



Stirling
Ultracold[®]

Part of **BioLife Solutions**



ULT25NEU

Operating

Manual



-86°C
Ultra-Low
Temperature
Freezer

ULT25NEU Quick Guide

INITIAL SETUP

Port Stopper/ Sealant	!	The Port Stopper/Sealant must be in place during operation
Power Indicator	A	The unit is ON when lit
Power ON	B	Press and hold for two beeps
Power OFF	B	Press and hold for three beeps
LCD Display	C	Displays chamber temperature
Display Setpoint	F	Press/Release to display current setpoint, S ## displayed
Return to Temp Display	F	Press/Release or wait eight seconds
Change Setpoint	F	Press and hold until Set T LED E glows, S ## displayed, then A or V D

ADVANCED FUNCTIONS

Change to Preset		Press and hold Set F until Set T LED E glows, S ## displayed, then select Preset 1, 2 or 3 J
Postpone Over Temperature Alarm		When Over Temp LED I glows, press Preset 3 J until time shows (1.0 h) (If Over Temp LED is not glowing, then Preset 3 acts as a Temp Preset)
Return to Temp Display		Wait eight seconds, press Preset 3 to return to temperature display
See Error Code Again		If Error LED H is glowing, press Preset 2 J briefly (If Error LED is not glowing, then Preset 2 becomes Temp Preset)
Lock Panel		Press and hold Preset 1 AND 2 AND 3 J until Locked LED G turns off (~five seconds)
Unlock Panel		Press and hold Preset 1 AND 2 AND 3 J until Locked LED G turns off (~five seconds)
LCD Display Codes		P ## – Preset Temp, ## h – Alarm Silenced, E ## – Error Code (see operating manual)

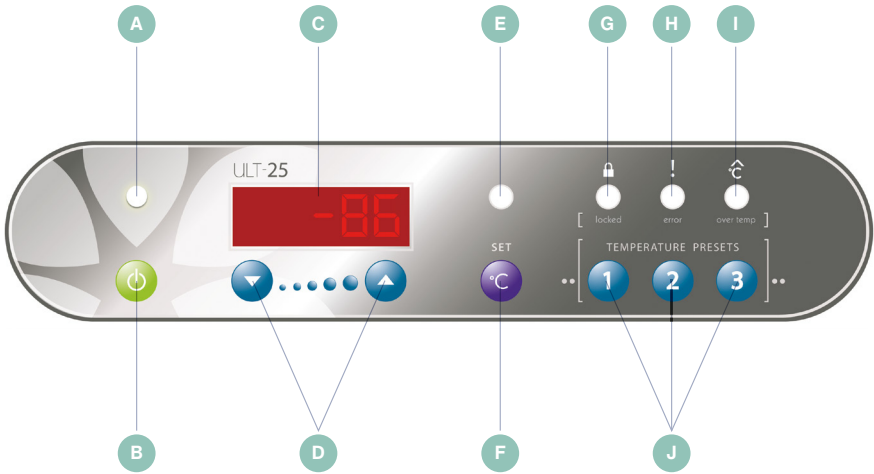

NOTICE:

When unit is first turned on, red **Over Temp LED** (I) will be on until temperature is within 10° of setpoint.

Panel cannot be locked until temperature is within 10° of setpoint. Panel cannot be locked until temperature is within 10° of set point.

THIS PAGE INTENTIONALLY LEFT BLANK

ULT25NEU

-86°C PORTABLE ULTRA-LOW TEMPERATURE FREEZER

The ULT25NEU (Ultra-Low Temperature, 25 liter volume) incorporates next generation free-piston Stirling engine technology. Free-piston Stirling engine technology differs from conventional compressor-based refrigeration in that it provides high efficiency, deep-temperature cooling in a lightweight package allowing true portable operation.

TABLE OF CONTENTS

1. SAFETY PRECAUTIONS	6	5. ERROR CODES	20
1.1 Injury Prevention	6		
1.2 Damage Prevention	7	6. MAINTENANCE	21
1.3 Transportation Care	8	6.1 Caring for Your Freezer Gasket	21
1.4 Flammable Refrigerant Use	8	6.2 Air Intake Filter	21
		6.3 Storage	21
2. UNPACKING AND SET-UP	9	6.4 Cleaning	21
3.1 Pictorial Tour, Freezer	11	7. TROUBLESHOOTING	22
3. FEATURES OF THE ULT25NEU FREEZER	11	8. CALIBRATION GUIDE	23
3.2 Pictorial Tour, Control Panel	13	9. SPECIFICATIONS	26
3.3 Power Cords	14	9.1 Freezer Specifications	26
3.4 Intended Uses	14	10. WARRANTY	30
4. OPERATION	15		
4.1 How to Turn the Freezer On/Off	15		
4.1.1 To Turn the Freezer On	15		
4.1.2 To Turn the Freezer Off	15		
4.2 Changing the Set Temperature	15		
4.2.1 To See the Current Set Temperature	15		
4.2.2 Change the Setpoint to a New Value	16		
4.3 Using Preset Temperatures	17		
4.4 Over-Temperature Alarm	18		
4.4.1 How to Silence the Audible Temperature Alarm	18		
4.4.2 To Postpone an Alarm	18		
4.5 Error Conditions	18		
4.6 Locking the Control Panel	19		
4.7 How to Switch Between Power Supplies	19		

1. SAFETY PRECAUTIONS

To prevent personal injury, injury to others, or damage to property, read these safety precautions carefully before use.

1.1 INJURY PREVENTION

- ⦿ **Do not** cut, change or modify the power cable.*
- ⦿ When removing the plug, hold onto the plug and not the cord.
- ⦿ An ultra-low temperature freezer is qualitatively different than a home freezer. At -86°C frostbite can occur instantly.
- ⦿ The user should establish and follow a protocol for safe ultra-low temperature operating procedures. This should include (but not limited to):
 - > **Never** handle samples or freezer accessories with bare hands.
 - > **Do not** use gloves which become brittle at ultra-low temperatures.
 - > Nitrile and latex gloves are inadequate.
- ⦿ Permeable gloves are dangerous because ultra-low temperature materials can contact skin and cause damage.
 - > Be especially careful that materials at ultra-low temperature are not spilled onto skin or clothing.
 - > Use only sample containers that have been approved or tested for ultra-low temperature use.
 - > Some plastics shatter at ultra-low temperatures. Avoid splinter hazards.
 - > Biological and chemical hazards are still hazardous at ultra-low temperature. Always wear proper protective equipment and follow appropriate isolation protocols.
 - > Many types of labels will fall off and/or break at ultra-low temperature. Some types of ink which stick to glass and/or plastic at room temperature lose adhesion at ultra-low temperature.
- ⦿ In addition to the ultra-low temperature hazards above, there are also physical hazards to consider:
 - > Be cautious when closing the lid to avoid a pinching hazard.
 - > Be careful when loading the box with heavy items.
 - > **Always** use the handles to carry the freezer.

1. SAFETY PRECAUTIONS (Continued)

1.2 DAMAGE PREVENTION

- ⚠ **Do not** disassemble, modify or repair. There are no user serviceable parts inside the freezer unit.*
- ⚠ **Do not** immerse in water or pour water on the unit.*
- ⚠ **Do not** put ice or liquid water directly in the freezer box, always use suitable containers.
- ⚠ **Do not** use glass containers when the contents might freeze and break.
- ⚠ **Do not** store flammable items such as gasoline, thinner or solvents in the freezer. The freezer is NOT rated as an explosion-proof freezer.
- ⚠ **Do not** use hard and/or sharp objects, such as knives, screwdrivers, etc. to remove any frost or ice which has accumulated on the inside of the freezer. The inside panels are heat exchangers and can be damaged.
- ⚠ **Do not** block the air intake or air discharge vents.
- ⚠ **Do not** drop, throw or abuse the freezer.*
- ⚠ **Do not** operate under extreme environmental conditions, such as in a car trunk, in very high humidity environments, in rain or other severe weather.*
- ⚠ **Do not** use solvents to clean the control panel or the outside or inside of the freezer.

*Warning: Unauthorized modification to the cabinet, controls or free-piston Stirling engine is prohibited and will void all warranty provisions.

1. SAFETY PRECAUTIONS (Continued)

1.3 TRANSPORTATION CARE

- Use only factory-provided packaging. If unavailable, contact the manufacturer for replacement packaging materials.
- **Do not** place unit on sides or turn upside down.

1.4 FLAMMABLE REFRIGERANT USE

ULT25NEU uses 10-12 grams of R-170 (Ethane) in a hermetically sealed thermosiphon tubing. It requires caution in use and repair.

- A Danger** – Risk of Fire or Explosion. Flammable Refrigerant Used.
Do Not Drill or Puncture Inner Liner.
- B Danger** – Risk of Fire or Explosion. Flammable Refrigerant Used.
To be Repaired Only by Trained Service Personnel. Component Parts Shall Be Replaced With Like Components. Do Not Puncture Refrigerant Tubing.
- C Caution** – Risk of Fire or Explosion. Flammable Refrigerant Used.
Consult Repair Manual/Owner's Guide Before Attempting to Service this Product. All Safety Precautions Must be Followed.
- D Caution** – Risk of Fire or Explosion. *Dispose of Properly in Accordance with Federal or Local Regulations.* Flammable Refrigerant Used.
- E Caution** – Risk of Fire or Explosion Due to Puncture of Refrigerant Tubing;
Follow Handling Instructions Carefully. Flammable Refrigerant Used.

2. UNPACKING AND SET-UP

- 1 Remove the freezer and all accessories from the box. Carefully inspect the freezer and all accessories for any shipping damage.
- 2 Check the packing list to verify that the shipment is complete.
- 3 Ensure the access port stopper or sealant is in place.
- 4 Place the freezer on a level surface.
- 5 Make sure that the air inlets and outlets are not blocked.
- 6 Connect to a power source. While the freezer can be used with either the AC Power Cord for lab, home or office use, or the DC Power Cord for mobile use, it is recommended that the initial pull-down to Setpoint be completed via AC power.

A To use the AC Power Supply:

- i During setup, identify the service power and plug configuration available and then locate the appropriate line cord for the service type you will be using.
- ii If the appropriate line cord is not currently installed, simply unplug the line cord from the unit and then plug the appropriate line cord in its place.
- iii Plug the other end of the line cord into the power source and then attempt to power on the unit.



B To use the DC Power Cord in a motor vehicle:

- i Make sure the freezer remains level. Exceeding an angle of 12 degrees may cause loss of cooling.
- ii Plug the DC Power Cord into a 12V outlet that is rated at 20 amps. NOTE: Not for use with 24 volt automotive systems.



Power Cord
Available Separately.

NOTE: Not for use with 24 volt automotive systems.

20 A DC REQUIREMENT: Consult your automotive specialist if your vehicle lacks 20 A rated 12V outlets.

- iii Plug the opposite end into the freezer. Slide the male line cord adapter into the female connection port, lining up the two plastic bungs on the male adapter with the cutouts in the female port of the freezer. Press the male adapter firmly into the connection port and turn clockwise until an audible “click” indicates full connection.

2. UNPACKING AND SET-UP (Continued)

7 Notes on operation in a vehicle.

- A** The freezer will operate on vehicle battery power for a limited time before the battery is drained and the motor vehicle cannot be started. This time will vary from vehicle to vehicle but is generally only a few hours.
 - B** The vehicle engine should be running to prevent accidental total discharge of the battery.
 - C** The power to 12V outlets in some vehicles may be interrupted during engine starting. This will cause a sudden stop of the cooling unit which may produce a sound that is different than when turning off the freezer by using the **On/Off** button. This is normal and will not damage the cooling engine. The cooling engine will restart automatically once power resumes.
 - D** **20 A DC REQUIREMENT:** Please note that 20 A DC service is required for proper functioning of the freezer in a motor vehicle. Some vehicles may not be equipped with 20 A DC service. Consult your automotive specialist to verify the level of DC service installed in your vehicle.
 - E** Do not operate the freezer in an unattended vehicle. This may lead to overheating if left in the sun and subsequent damage to stored contents.
-

8 Disconnecting from power.

- A** Turn off the freezer (Press and hold **On/Off** button for three beeps).
 - i** The LCD display will show the word “OFF” while the unit turns off.
 - ii** Unplug the freezer after the word “OFF” disappears and the display goes dark.
 - iii** If you unplug the freezer while it is on, you will hear a sudden noise as the free-piston Stirling engine shuts off. Power outages will also cause the same noise. This noise (described as a “bonk”) is not indicative of damage.

3. FEATURES OF THE ULT25NEU FREEZER

3.1 PICTORIAL TOUR, FREEZER

The Stirling Ultracold ULT25NEU free-piston Stirling engine ultra-low temperature freezer has the following features:

- 1 **A freezer chamber which is protected by two lids**
 - > Inner lid has a tight fitting foam lid.
- 2 **Control Panel**
 - > Described in more detail on page 13.
- 3 **Lid Latch**
 - > For positive closure.
- 4 **Access Port**
 - > For thermocouple wires, etc.
- 5 **Cleanable Filter**
 - > Helps protect the heat rejection fins from dust.
- 6 **AC Power Connection**
 - > Polarized to avoid error.
- 7 **DC Power Connection**
- 8 **Temperature Probe Clip (optional)**
 - > For holding the temperature probe in place for calibration and monitoring.
- 9 **Remote Alarm Contacts (optional)**
- 10 **Key Lock**
 - > Locking lid for sample integrity.
- 11 **Power Supply Fan**
- 12 **Vent**



3. FEATURES OF THE ULT25NEU FREEZER (Continued)

1



Outer Lid:
double gasket
moisture seal.

Inner Lid:
high-density,
closed cell,
rigid foam.

4

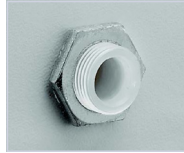

Access Port:
1/4" (6.3 mm).

5



Slide-out Filter:
easy to clean, protects
heat rejection fins.

6



AC Power Connection.

Power Cord Available
Separately.

7



DC Power Connection.

Power Cord
Available Separately.



11

6

8



Temperature Probe Clip
(optional).

9



Remote Alarm
Contacts (optional).

3. FEATURES OF THE ULT25NEU FREEZER (Continued)

3.2 PICTORIAL TOUR, CONTROL PANEL

A On/Off Indicator LED

B On/Off button

> Turns freezer on and off.

C LCD display

> Alpha/numerical display; default display is chamber temperature.

D ^ / v buttons

> Used to adjust Setpoint Temperature (when the display shows S ##).

E Set Temp LED

> Temperature can be adjusted when lit.

F Set Temp button

> This must be pressed to adjust the Set Temperature.

G Locked LED

> Indicates when the control panel is locked.

H Error LED

> Indicates when there is an electrical, mechanical or similar error condition.

I Over Temp LED

> Indicates when the chamber is over/under the setpoint.

The audible beeper can be set to delay warning.

J Temperature Preset buttons

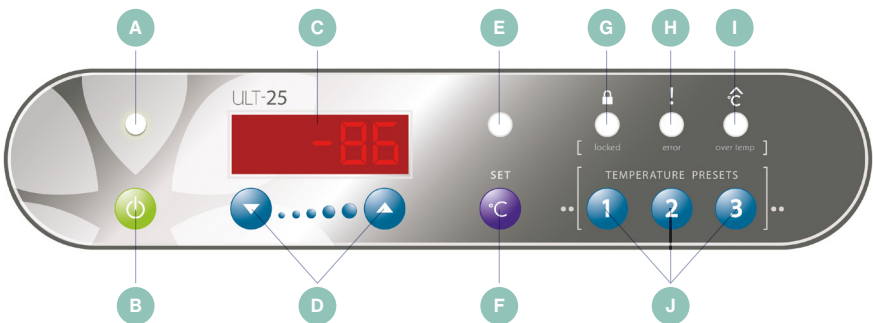

3. FEATURES OF THE ULT25NEU FREEZER (Continued)

3.3 POWER CORDS

A simple line cord change can allow for multiple power and receptacle types. See Section 4.7 for directions.

Make sure to use the cord and plug appropriate for your location.

Power supply options include:

- North America. 120VAC 60Hz. NEMA 5-15P plug and 240VAC 60Hz. NEMA 6-15P plug.
- Europe/International. 240V, AC, 50Hz. Standard two-pin plug.

3.4 INTENDED USES

The ULT25NEU freezer provides ultra-low temperature storage for both medical and non-medical purposes. The storage of blood or blood products intended for medical purposes is prohibited.

4. OPERATION

Important changes to the freezer settings require sustained button pushes. This helps prevent accidental changes to the settings during transportation. Some sequences require a three-second button press and hold while other sequences require a five-second button press and hold.

For example,

*Turning the freezer ON requires a three-second press and hold (two beeps).
Turning the freezer OFF requires a five-second press and hold (three beeps).*

The default display is the chamber temperature. Other displays such as Setpoint, Alarm Postpone, etc., are marked with a letter such as S (Setpoint), h (Alarm Postpone), etc. These secondary displays revert to the default display after approximately eight seconds of button inactivity.

4.1 HOW TO TURN THE FREEZER ON/OFF

4.1.1 To Turn the Freezer On

- ◆ Press and hold the **On/Off** button for two beeps (~three seconds).
- ◆ The freezer will display a greeting message, and then display the chamber temperature.

4.1.2 To Turn the Freezer Off

- ◆ Press and hold the **On/Off** button for three beeps (~five seconds).
- ◆ The freezer will display “OFF” for 10 seconds, and then go dark.

4.2 CHANGING THE SET TEMPERATURE

4.2.1 To See the Current Set Temperature

- ◆ Press the **Set Temp** button briefly.
- ◆ The current set temperature will be displayed with the letter S ##.
 - > After eight seconds of inactivity the display will revert to the current temperature.

4. OPERATION (continued)

4.2.2 Change the Setpoint to a New Value

- There are two ways to change the Setpoint.
 - > Manually adjust the temperature using **^ / v** .
 - > Use one of the three adjustable **Preset Buttons**.
- Adjusting the Setpoint manually.
 - > Because of the importance of the Setpoint Temperature, changing the Setpoint requires a “two-button procedure”. This means:
 - **Method A** – press/hold the **Set Temp** button while simultaneously pressing **^ / v**.
OR
 - **Method B** – press/hold the **Set Temp** button until the Set Temp LED glows and then press **^ / v** .
(Methods A and B achieve the same effect. The user can use whichever method they prefer.)
- To change the Setpoint by **Method A**
 - > Press and hold the **Set Temp** button and then push the **^ / v** buttons (do not release the **Set Temp** button).
 - The Setpoint temperature will appear with the prefix S in the LCD display.
 - When the **^ / v** buttons are first pushed the Setpoint will change by 1°C at first.
 - If the **^ / v** buttons are held for five seconds the step size will increase/decrease by 5°C.
 - If the **^ / v** buttons are briefly released (less than a half second) while continuing to hold down the **Set Temp** button the increment/decrement size will return to 1°C.
 - Release all buttons once the desired Setpoint is achieved. The display will return to chamber temperature after about eight seconds.

4. OPERATION (continued)

⦿ To change the Setpoint by **Method B**

- > Press and hold the **Set Temp** button until the **Set Temp LED** glows.
 - The Setpoint temperature will appear with the letter S in the first LCD display.
- > The **^ / v** buttons can be used to change the Setpoint.
 - When the **^ / v** buttons are pushed the Setpoint will change by 1°C at first.
 - If the **^ / v** buttons are held for five seconds the step size will increase to 5°C.
 - Briefly release (a half second) the **^ / v** buttons while continuing to hold down the **Set Temp** button the increment/decrement size will return to 1°C.
 - Release the **^ / v** buttons once the desired Setpoint is achieved.
- > Press the **Set Temp** button briefly (less than one second) to turn off the **Set Temp LED**. The display will return to chamber temperature.

4.3 USING PRESET TEMPERATURES

- ⦿ The Temperature Presets — 1, 2 and 3 can be used to quickly change the Setpoint to frequently used values. When shipped the Presets are set to -86°C, -40°C, and -20°C.
- ⦿ To choose one of the preset temperatures:
 - > Press and hold the **Set Temp** button until the **Set Temp LED** glows.
 - > Push one of the Temperature Preset buttons briefly.
 - > The new Set Temperature will be shown in the LCD display.
 - > If this is the desired Set Temperature, the user can either:
 - Briefly press the Set Temp button to turn off the **Set Temp LED**.
OR
 - Wait for approximately eight seconds when the freezer control panel will return to normal operation.

4. OPERATION (continued)

4.4 OVER-TEMPERATURE ALARM

- If the freezer compartment temperature is 10°C warmer or colder than the Setpoint for five seconds then it will go into temperature alarm mode.
 - > The **Over Temp LED** will turn on (this is used for under temperature alarms as well).
 - > The freezer will make a double beep every 10 seconds.
 - > Situations which can affect the freezer's ability to maintain a steady state or cooling rate include:
 - The lid is ajar
 - The air vents are blocked
 - Addition of a large relatively warm mass
 - Power supply problems
 - Mechanical and/or electrical problems.

4.4.1 How to Silence the Audible Temperature Alarm

- The **Over Temp LED** will always be lit when the freezer's temperature is over or under the set temperature by more than 10°C.

4.4.2 To Postpone an Alarm

- When the audible alarm is sounding it can be postponed.
- Press the **Temperature Preset – 3** button (located directly beneath the **Over Temp LED**) and the audible alarm will be turned off for 1 hour.

4.5 ERROR CONDITIONS

- Certain conditions will cause an Error Code to be displayed on the LCD display, and the **Error LED** will be lit.
 - > The error code will be of the form E ##, where ## is the error code. See Section 5 for possible error codes.
 - > The error code will be displayed for about five seconds and then the display will show the chamber temperature. The **Error LED** will stay on.
 - > The error code can be recalled by briefly pressing the **Temperature Preset – 2** button, located directly under the **Error LED**. This will recall the error code for approximately 10 seconds.
 - > If the **Temperature Preset – 2** button is pressed and held for five seconds (three beeps) this will clear both the LCD display and the Error LED. However, if the error condition persists the error cycle will start over again.

4. OPERATION (continued)

4.6 LOCKING THE CONTROL PANEL

To Lock the Freezer Control Panel

- ◉ Press and hold the **Temperature Preset 1, 2 and 3** buttons until the freezer beeps three times.
 - > The **Locked LED** will light up.
 - > The control panel cannot be locked if there is an over temperature or other error condition.

To Unlock the Freezer Control Panel

- ◉ Press and hold the **Temperature Preset 1, 2 and 3** buttons until the freezer beeps three times.
 - > The Locked indicator LED will turn off.
 - > The freezer will still indicate over-temperature alarms or error conditions while it is locked. The user has to unlock the control panel to address those alarms/conditions.

4.7 HOW TO SWITCH BETWEEN POWER SUPPLIES

- ◉ See Section 3.3 for possible power sources for the ULT25NEU.
- ◉ To change from one power supply to another:
 - > Turn OFF the freezer (Press and hold the **On/Off** button).
 - > Wait for the free-piston Stirling engine to slow and stop (15 seconds).
 - > Unplug the freezer from the current power source and plug into the new, approved power source. Reference Section 2, Part B for instructions on use of a DC Power cable.
 - > The freezer can be restarted immediately, no wait time necessary.
 - > Turn ON the freezer by pressing and holding the **On/Off** button.

5. ERROR CODES

These are displayed in the LCD display as E ##.

10 The free-piston Stirling engine is not maintaining a working temperature. This could arise from blocked filters, blocked air passages, unusually hot ambient temperatures (for example $>45^{\circ}\text{C}$), or a fan failure. Check air passages and clear any blockages for good air circulation. Remove from hot environments (car interiors, etc.).

40 A component which monitors free-piston Stirling engine performance has failed. The free-piston Stirling engine cannot regulate itself. Please return for repair.

6. MAINTENANCE

6.1 CARING FOR YOUR FREEZER GASKET

The temperature differential between ambient and the ultra-low interior can attract moisture near the gasket. For best results always wipe away moisture during openings to prevent ice accumulation. Do not use sharp instruments to scrape ice from the surface.



6.2 AIR INTAKE FILTER

Clean accumulated dust and dirt on the air intake filter every month. Pull the filter cover to the left as shown. Please note that it cannot be completely removed. Gently clean the filter with a vacuum cleaner. If there are stubborn residues use a soft brush to work them loose.



6.3 STORAGE

- 1 Turn off the power and allow the freezer to come to room temperature.
- 2 Dry the inside of the freezer compartment and clean any spills.
- 3 Disinfect with suitable sterilizing agent if the freezer has been used for biohazards.

6.4 CLEANING

The exterior surfaces of the freezer can be cleaned as needed by using a soft cloth and mild detergent. Do not use solvent or harsh abrasive cleansers or pads.

7. TROUBLESHOOTING

Problem	Possible Cause	Solution
Freezer does not power on	Power is not getting to the freezer from the AC input	Check the connections to the power supply
		Assure that the wall plug is firmly seated
	Power is not getting to the freezer from the DC input	Reseat the connections to the DC power cord
		Assure that the DC input has live power
Freezer does not achieve desired temperature	Inadequate air circulation	Clean air filter screen
		Remove air flow obstructions
	Inadequate power	Assure that the wall plug is firmly seated
		Remove any dirt or debris inside the automotive DC socket or on the plug
		Operate freezer only when automobile is running
	Improper environment	Remove freezer from direct sunlight, hot room, etc
		Check that freezer is level. Tilts of more than 12 degrees in some directions will degrade performance
Freezer cools slowly	Overloading of freezer	Remove some items from freezer
	Lid is not completely closed	Check for ice buildup, remove if necessary, and properly close lid
	Lid is open and closed too often	Minimize opening and closing of lid
	Inadequate air circulation	Clean filter and unblock air vents
12V plug becomes unusually hot	Dirt or corrosion in the DC socket	Clean the socket

8. CALIBRATION GUIDE

CALIBRATING THE RTD WITH AN INDEPENDENT TEMPERATURE INDICATOR

The ULT25NEU's Resistance Temperature Device (RTD) is factory calibrated to display both setpoint and operating temperature from a single internal RTD. In the event that you must recalibrate the unit to match the reading of an independent temperature recording device or stand-alone electronic thermometer, please follow this process.

1 Tools Required

- ⦿ Flashlight or work light
- ⦿ Long handled (6-7"), Phillip's or flathead screwdriver
- ⦿ Independent Thermocouple and a NIST traceable temperature measuring device with sufficient lead wire to pass through the 1/8" access port and affix to the vertical liner channel
- ⦿ Tape.

8. CALIBRATION GUIDE (Continued)

2 Procedure

- 1 Place a thermocouple inside the cabinet via access port ① and insert plug/port sealant. **Note:** Display temperature is calibrated using a NIST traceable thermocouple located in the center of the cabinet (4.4" from back, 6.6" from left side, 6.7" from bottom).
 - 2 Turn unit on.
 - 3 Set temperature to -80°C.
 - 4 Wait until the display reads -80°C. For best results wait an additional hour to ensure uniform cabinet temperature.
 - 5 Connect a NIST traceable temperature measuring device ② to the thermocouple located inside the cabinet.
 - 6 Slide open filter door located on the side of the cabinet ③.
 - 7 Using an extra-long screwdriver ④ locate the potentiometer through filter opening ⑤.
 - 8 Turn the adjustment screw until the display temperature is the same as the hand-held instrument. **¼ Turn = 3 DEGREES.**
 - 9 Turn the screw to change the temperature indicated on the display (clockwise for warmer and counter-clockwise for colder).
 - 10 After making an adjustment, **WAIT 15 SECONDS** for the unit's indicated temperature to register the adjustment. Repeat adjustment if necessary.
 - 11 Calibration complete.
-

8. CALIBRATION GUIDE (Continued)

1

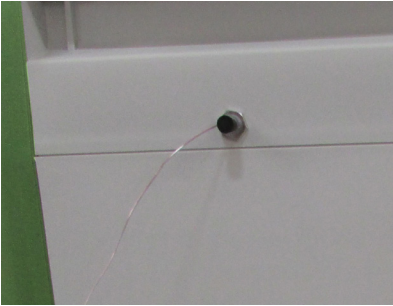

Thermocouple through Access Port & Access Port Plug.

2



NIST Traceable Temperature Measuring Device.

3



Filter Door.

4

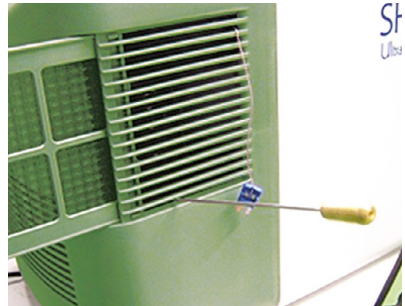

Adjustment Tool.

5

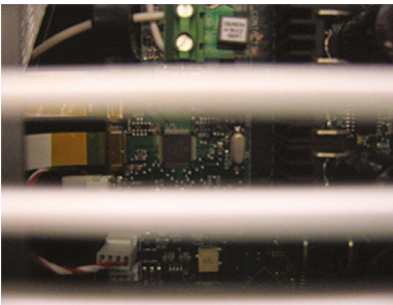

Calibration Screw visible through filter.

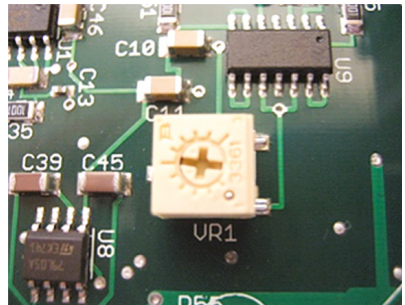

9. SPECIFICATIONS

9.1 FREEZER SPECIFICATIONS

Electric Power	100V – 240 (± 10%) at either 50 or 60 Hz or 12V DC from mobile source
Maximum Power (Current)	280 watts (4 amps @120VAC, 2 amps @240VAC, 15 amps@12VDC)
Electric Supply Rating	15 amp or greater grounded circuit
Cooling Engine	Helium charged free-piston Stirling engine with continuous modulation
Refrigerant	R-170 (Ethane), 10-12 grams
Temperature Range	-86°C to -20°C @ 32°C (90°F) ambient, uniformity ± 3°C at -80°C top to bottom, adjustable in 1°C increments Presets for -86°C (default), -40°C and -20°C
Environmental Conditions	<ul style="list-style-type: none">- Non-corrosive, non-flammable, non-explosive- Indoor use- Altitude up to 2,000m- Temperature 5°C to 40°C (41°F to 104°F)- Maximum relative humidity 80% for temperature up to 31°C decreasing linearly to 50% at 40°C
Storage Volume	25 liters (0.9 cu. ft.)
Interior Dimensions	332 x 221 x 340 mm 13.1" x 8.7" x 13.4" (L x W x D)

9. SPECIFICATIONS (Continued)

Exterior Dimensions	692.5 x 350 x 460 mm 27.3" x 13.8" x 18.1" (L x W x D)
Net Weight, Empty	21 kg (46 lbs.), nominal
Insulation	High performance vacuum insulated panels and polyurethane foam using environmentally friendly CO ₂ blowing agent
Noise	Advanced noise abatement, <45 dB(A) at 1 meter
Control Sensor	One RTD (PT100 Class A)
Dry Contacts	Optional
Steady State Energy Use 25°C Ambient	2.8 kWh/day (average power 118 watts) at -80°C (Empty Cabinet)
Pull-Down from 25°C Ambient	4 hours at -80°C (Empty Cabinet)
Recovery from 1 minute lid opening	20 minutes to -80°C (Empty Cabinet)
Warm-Up Profile	30 minutes to -60°C (Empty Cabinet) 70 minutes to -40°C (Empty Cabinet)
Heat Dissipation	403 BTU/H (load to HVAC) (Empty Cabinet)

9. SPECIFICATIONS (Continued)

9.2 FREEZER DIMENSIONS

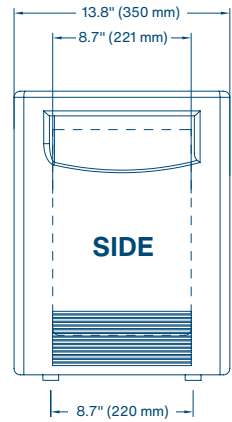
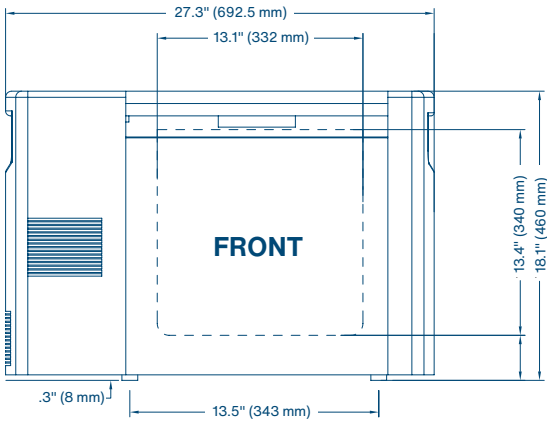
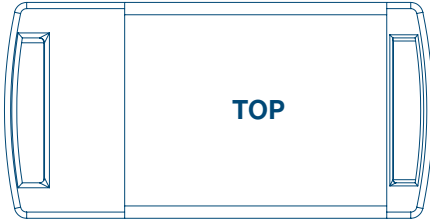

9. SPECIFICATIONS (Continued)

9.3 PULL-DOWN AND WARM-UP CHARACTERISTICS, 25°C AMBIENT

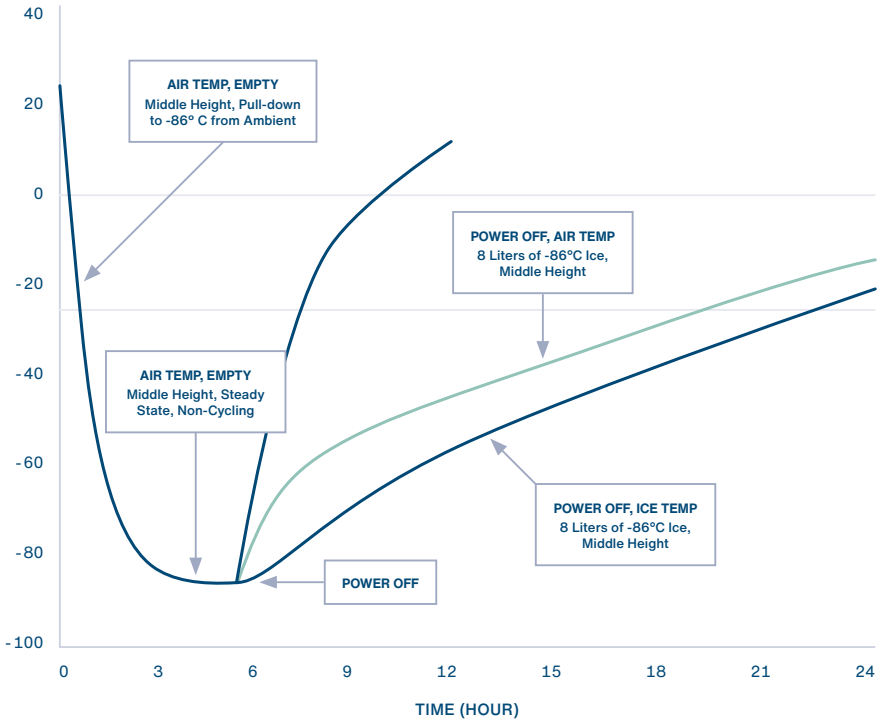

10. WARRANTY

The following Warranty applies to the ULT25NEU manufactured by Stirling Ultracold, a division of Global Cooling, Inc. Due to the nature and size of the ULT25NEU, a product exchange may be preferable to field-level service. In order to maintain maximum uptime and to optimize customer service, Global Cooling, Inc. reserves the right to exchange the ULT25NEU with a serviceable new or previously-used replacement at its discretion.

LIMITED WARRANTY, USA

- The warranty period starts **TWO WEEKS** after the original date of shipment from Global Cooling, Inc.
- The ULT25NEU is warranted for a period of **ONE YEAR** for materials and labor at our factory.
- If a service issue arises, contact the Global Cooling, Inc. Service Department to register Warranty Service and initiate a resolution.
- Advanced authorization for a service company to diagnose the problem must be approved by Global Cooling, Inc.
- Global Cooling, Inc. will not be responsible for charges incurred for service calls made by a third party prior to authorization by Global Cooling, Inc.
- Global Cooling, Inc. retains the right to replace any product in lieu of servicing it in the field.
- Liability in all events is limited to the purchase value only.
- Under no circumstances will Global Cooling, Inc. be responsible or held liable for consequential or incidental damages associated with loss of stored product in the event of an equipment failure.

10. WARRANTY (Continued)

LIMITED WARRANTY, CANADA

- The warranty period starts **ONE MONTH** after the original date of shipment from Global Cooling, Inc.
- The Stirling Ultracold ULT25NEU is warranted for a period of **ONE YEAR** for materials and labor at our factory.
- If a service issue arises, contact the Global Cooling, Inc. Service Department to register Warranty Service and initiate a resolution.
- Advanced authorization for a service company to diagnose the problem must be approved by Global Cooling, Inc.
- Global Cooling, Inc. will not be responsible for charges incurred for service calls made by a third party prior to authorization by Global Cooling, Inc.
- Global Cooling, Inc. retains the right to replace any product in lieu of servicing it in the field.
- Under no circumstances will Global Cooling, Inc. be responsible or held liable for consequential or incidental damages associated with loss of stored product in the event of an equipment failure.

INTERNATIONAL DISTRIBUTOR LIMITED WARRANTY

- The warranty period starts **TWO MONTHS** after the original date of shipment from Global Cooling, Inc.
- The ULT25NEU is warranted for a period of **ONE YEAR** for materials only.
- If a service issue arises, contact the International Distributor from where the ULT25NEU was purchased. The Distributor will contact the Global Cooling, Inc. Service Department to register Warranty Service and initiate a resolution.
- Global Cooling, Inc. must provide advanced authorization for the Distributor's service company to diagnose the problem at the customer's site.
- Neither Global Cooling, Inc. nor the Distributor will be responsible for charges incurred for service calls made by a third party prior to authorization by the Distributor or Global Cooling, Inc.
- Global Cooling, Inc. and the Distributor retain the right to replace any product in lieu of servicing it in the field.
- The Distributor must provide Global Cooling with proper troubleshooting information.
- Under no circumstances will Global Cooling, Inc. or the Distributor be responsible or held liable for consequential or incidental damages associated with loss of stored product in the event of an equipment failure.

THIS PAGE INTENTIONALLY LEFT BLANK

THIS PAGE INTENTIONALLY LEFT BLANK



Stirling Ultracold

6000 Poston Road, Athens, Ohio 45701, USA

T 740.274.7900 / 1.855.274.7900 | **F** 740.274.7901

BioLifeSolutions.com

©2023 Stirling Ultracold, a part of BioLife Solutions. All Rights Reserved.

Global Cooling technology is manufactured under U.S. and International patents.
Stirling Ultracold is a trademark of Global Cooling, Inc.
Specifications subject to change without notice.

Refer to BioLifeSolutions.com for the latest specifications.

