

STIRLING VAULT100™
OPERATING
MANUAL



-20°C to -100°C
Upright Ultra-Low
Temperature Freezer

REDEFINING COLD



THIS PAGE INTENTIONALLY LEFT BLANK







VAULT100 QUICK GUIDE

— clip, laminate, keep with freezer —



INITIAL SETUP

- 1 Unpack freezer unit and included components, ensure all packaging material has been removed from GUI.
- 2 Adjust the leveling feet (wrench included) to secure the freezer in place.
- 3 Plug AC power cord into the main power socket at the back of the unit and then into an electrical outlet of 120-240Vac, 50/60Hz.
- 4 Switch AC power to the "On" position.
- 5 **Notice:** Ensure the access port plug is in place.
- 6 Review the date, time, and temperature setpoint within the Graphical User Interface and adjust as needed. Default setpoint is -80°C.

GUIDE TO BASIC GRAPHICAL USER INTERFACE (GUI) FUNCTIONS

ON/OFF	Switch the main power on, located at the back of the unit adjacent to the AC cord.
Enable/Disable PINs	Tap Configurations Icon  > PIN > Enter New PIN and Confirm New PIN > Save Tap Service Icon  > PIN > Enter Service PIN > Enter Current PIN, New PIN, and Confirm New PIN > Save <i>To disable, enter Current PIN and complete the process leaving New PIN and Confirm New PIN blank.</i>
Change Setpoint	Tap Configurations Icon  > Enter PIN* > Enter* > Settings > Setpoint Temperature > +/- to adjust > Save
Silence Alarm	Tap Speaker Icon  in bottom-right corner
Event Log	Tap Information Icon  > Event Log > touch & drag to scroll up/down
Charts	Tap Charts Icon  > Select Chart Period > use left/right arrows to view

GUIDE TO ADVANCED GUI FUNCTIONS

Alarm Set-Up	Tap Configurations Icon  > Enter PIN* > Enter* > Alarms > Select Alarm Type > +/- to adjust > Save
Date and Time	Tap Configurations Icon  > Enter PIN* > Enter* > Settings > Date / Time > Select Date/Time component > +/- to adjust > Save
Calibrate RTDs	Requires Authorized Service & PIN* Tap Service Icon  > Enter Service PIN > Enter > Engine > RTD Calibration > +/- to adjust > Save

*If PIN is enabled

Download Operator and Quick Guide Manuals in the language of choice at: stirlingultracold.com/manuals



Handle Operation

The Stirling Ultracold handle is designed for one-handed operation. To open the freezer, rotate handle towards the user approximately 90°. To engage the Power-Release, apply firm downward pressure on the handle while in its open position. The Power-Release assists when the freezer door is adhered to the gasket after long periods of non-use as well as when air pressure is not yet equalized. To close, with handle in the horizontal position, push door to cabinet and return the handle to its original vertical position.

CAUTION:

Tipping Hazard

The unloaded freezer is TOP HEAVY. Use caution in moving and installation. Do not pitch the freezer more than 12 degrees from horizontal. Doing so may cause it to tip over.

DANGER:

Flammable Refrigerant Used, Risk of Fire or Explosion

VAULT100 uses 90 grams of R-170 (Ethane) in a hermetically sealed thermosiphon tube. It requires caution in use/repair.

- A. **Danger** – Do not drill or puncture inner liner.
- B. **Danger** – To be repaired only by authorized service providers. Do not puncture refrigerant tubing.
- C. **Caution** – Consult Service Manual/ Operating Manual before attempting to service this product. All safety precautions must be followed.
- D. **Caution** – Dispose of flammable refrigerant property in accordance with federal or local regulations.
- E. **Caution** – Follow handling instructions carefully.

TABLE OF CONTENTS:

1	<u>INTRODUCTION</u>	5-6	6	<u>MAINTENANCE</u>	44-47
1.1	General	5	6.1	Preventative Maintenance Schedule	44
1.2	Intended Use & Environmental Conditions	5	6.2	Operator Maintenance	46
1.3	Product Description	5	7	<u>REMOTE MONITORING</u>	48
2	<u>OPERATOR SAFETY & PRECAUTIONS</u>	7-15	7.1	BACnet	48
2.1	User Advisory	7	7.2	Dry Contacts	48
2.2	Operator Precautions	7	7.3	4-20mA (optional)	48
2.3	Safety Symbols & Language	7	8	<u>BACKUP SYSTEMS</u>	49
2.4	Special Safety Precautions	9	8.1	LN2 Backup System (optional): Hardware Installation	49
2.5	General Safety Precautions	11	8.2	CO2 Backup System (optional): Hardware Installation	49
3	<u>FREEZER PICTORIAL TOUR</u>	16-17	9	<u>SAMPLE MANAGEMENT & RACKING</u>	50-55
3.1	Cabinet	16	9.1	General Precautions	50
3.2	Electrical Panel	17	9.2	Available Storage Volume without shelves	50
3.3	Accessory Panel	17	9.3	Available Storage Volume with shelves	51
4	<u>INSTALLATION & SETUP PROCEDURE</u>	18-22	10	<u>SPECIFICATIONS</u>	56-59
4.1	Installation Site Qualifications	18	10.1	Performance Data	58
4.2	External Dimensions & Operating Floor Plan	19	10.2	Materials Specifications	59
4.3	Included Items	19	11	<u>OPERATOR TROUBLESHOOTING</u>	60-61
4.4	Unpacking	19	12	<u>WARRANTY</u>	62
4.5	Casters/Leveling Feet	20	A	<u>APPENDIX A</u>	
4.6	Moving the Freezer	20	A1	Information: Data Export	
4.7	Access Port Setup	21	A2	Configuration: Alarms	
4.8	Electrical Power Connection	21	A3	Alarms & Alerts/Reminders	
4.9	Setup	22			
5	<u>OPERATION</u>	23-43			
5.1	General Considerations	23			
5.2	Power Switch & Battery Operations	23			
5.3	Handle Operations	23			
5.4	Graphical User Interface (GUI)	24			
5.5	Managing Freezer Contents	42			

1 INTRODUCTION

1.1 GENERAL

This operating manual is a guide to installing, operating, and maintaining the Stirling VAULT100 ultra-low temperature (ULT) freezer. Downloading of this manual to a portable device so it can be referred to as needed, is recommended.

Be sure to read this manual in its entirety before attempting to handle or operate the freezer. Failure to follow the instructions in this manual can result in damage to the unit, injury to operating personnel, and/or impact equipment performance.



CAUTION: Observe all precautions and safety instructions to avoid damage to the freezer or harm to its users.

1.2 INTENDED USE & ENVIRONMENTAL CONDITIONS

The Stirling Ultracold VAULT100 freezer provides ultra-low temperature storage for general (non flammable) research laboratory materials that require a stable, computer-controlled, deeply-frozen environment.

The storage of blood or blood products intended for medical purpose is prohibited.

The Stirling VAULT100 is classified for use as stationary equipment in a Pollution Degree 2 and Overvoltage Category II environment. It is designed for indoor use in a laboratory or similar clean, climate-controlled space.

- Indoor Use
- Altitude up to 2000 m (6,562 ft)
- Maximum relative humidity 80% for temperatures up to 31°C (87°F), decreasing linearly to 50% relative humidity at 40°C (104°F)
- Mains supply voltage fluctuations not to exceed $\pm 10\%$ of the nominal voltage.

Operation outside of these conditions may compromise its safety systems or damage the freezer.

1.3 PRODUCT DESCRIPTION

1.3.1 Free-Piston Stirling Engine

The Stirling Ultracold Model M6D free-piston Stirling engine produces less heat than a traditional compressor-style engine. It provides quiet, high-efficiency, ULT cooling without the use of HCFC or HFC refrigerants. The M6D Stirling engine uses approximately 10 grams (0.35 oz.) of helium gas as a working fluid. Approximately 90 grams (3.2 oz.) of R-170 (Ethane) is used in the thermosiphon which removes heat from the interior.

1.3.2 Cabinet

The cabinet utilizes vacuum-insulated panels with non-HFC polyurethane foam support to provide an internal volume of approximately 795 liters.

1 INTRODUCTION (Continued)

The freezer panels are insulated with environmentally friendly, Significant New Alternatives Policy (SNAP) compliant blowing agent Ecomate®. The outer door is sealed with a single 7-chamber, 2-rib gasket, that is replaceable. An integrated gasket heater minimizes ice deposits on the gasket to cabinet interface.

1.3.3 Handle

The Stirling Ultracold VAULT100 handle is designed for one-handed operation. To open the freezer, rotate handle towards the user approximately 90°. To engage the Power-Release, apply firm downward pressure on the handle while in its open position. The Power-Release assists when the freezer door is adhered to the gasket after long periods of non-use as well as when air pressure is not yet equalized. To close, with handle in the horizontal position, push door to cabinet and return the handle to its original vertical position.

1.3.4 Graphical User Interface

The freezer is controlled using a graphical user interface (GUI) implemented on a touchscreen. The GUI provides users with key information such as temperature history and a detailed event log. It contains optional PIN-protected configurations and service screens where freezer controls can be adjusted (see Section 5 for more details).

1.3.5 Temperature Monitoring

The Class A Resistance Temperature Detector (RTD) measures the internal cabinet temperature of the Stirling VAULT100. The RTD provides input to the controller and GUI for reporting and logging. The GUI provides a door open time-out alarm and monitors the temperature for instances exceeding high and low limits (this can be set automatically or adjusted manually).

2 OPERATOR SAFETY & PRECAUTIONS

2.1 USER ADVISORY

Always take proper precautions when operating ultra-low temperature freezers. The Stirling VAULT100 is intended for storage of frozen sample products or vials at ultra-low temperatures.

Stirling Ultracold, a Division of Global Cooling, Inc., cannot be held responsible for damages or loss of stored product attributed to unintended use. In no case will Stirling Ultracold, a Division of Global Cooling, Inc., be held liable for loss of stored product resulting from electrical, mechanical, or structural failure.

As with any ultra-low temperature freezer, appropriate back-up and redundancy considerations are strongly encouraged and are the responsibility of the user. Basic safety measures should always be followed when using the Stirling VAULT100. This includes heeding the warnings and cautions listed on the product and in this operating manual. If the equipment is used in a manner not specified by the manufacturer, the protection provided by the equipment may be impaired. The appliance is not to be used by persons (including children) with reduced physical, sensory or mental capabilities, or lack of experience and knowledge, unless they have been given supervision or instruction. Children are not to play with the appliance.

2.2 OPERATOR PRECAUTIONS

Potential hazards associated with use of the Stirling VAULT100 may impact the safety of persons in the workplace in which the freezer is installed. This includes persons who operate the freezer and other personnel in its vicinity. All personnel that install, operate, transport, or place the freezer into storage should read this entire manual to understand these hazards. Further precautions are included in installation, maintenance, and service documentation.

This section contains the language and symbols used to describe the precautions necessary to operate the Stirling VAULT100 safely. Some of the safety instructions are included in this section but many are distributed to the appropriate section of the manual.

This section also includes the precautions necessary to prevent damage to the freezer. The freezer itself may be damaged and/or its warranty voided by improper operation or usage.

2.3 SAFETY SYMBOLS AND LANGUAGE

2.3.1 Definitions of Hazard Terms

The following terms will be used on the product and throughout this manual to describe the potential hazards associated with operating the Stirling VAULT100 Freezer.

2 OPERATOR SAFETY & PRECAUTIONS (Continued)

DANGER: Indicates potentially hazardous situations which, if not avoided, will result in serious injury or death.

WARNING: Indicates potentially hazardous situations which, if not avoided, could result in serious injury or death.

CAUTION: Indicates a potentially hazardous situation which, if not avoided, could result in minor to moderate injury or damage to the equipment.

NOTICE: Indicates important operating instructions, which could reduce the risk of injury or poor performance of the unit.

2.3.2 Definitions of Hazard Symbols

The following symbols will be used on the product and throughout this manual to indicate the potential hazards associated with operating the Stirling VAULT100 Freezer.



Information Symbol: Consult the Operating Manual in all cases where the Information Symbol is used. Observe all precautions and safety instructions to avoid damage to the freezer or harm to its users.



Cold Hazard Symbol: Hazards from cold temperature are present during operation of the unit.



Fire Hazard Symbol: Hazards from potential fire present during handling and service of the unit. These hazards are related to flammable refrigerant and backup battery.



Do not Drill or Puncture Symbol: Hazards from drilling or puncturing the cabinet are present during operation and service of the unit. Drilling or puncturing the cabinet liners will increase the risk of a flammable refrigerant leak as well as damage to the insulation.



Electrical Hazard Symbol: Hazards from electricity are present during operation and service of the unit. These hazards are related to management of the power cord and servicing the unit with the top cover removed.



Tipping Hazard Symbol: Hazards from tipping are present during unpacking or moving the unit.



Hand Crushing Hazard Symbol: Keep hands away from the door frame when closing to avoid injury.



Manual Symbol: This symbol indicates that there is important information in the Manual.



Disposal Symbol: The WEEE (Waste Electrical and Electronic Equipment) symbol indicates compliance with the European Union Directive. The directive sets requirements for the labeling and disposal of certain products in affected countries. When disposing of this product in countries affected by this directive:

2 OPERATOR SAFETY & PRECAUTIONS (Continued)

- Do not dispose of this product as unsorted municipal waste.
- Collect this product separately.
- Use the collection and return systems available locally. For more information on the return, recovery or recycling of this product, please contact your local distributor or Stirling Ultracold.

2.4 SPECIAL SAFETY PRECAUTIONS

Please consider the following special safety precautions for ULT Freezers in general and Stirling engine based ULT Freezers including the Stirling VAULT100.

2.4.1 Ultra-Low Temperature (ULT) Precautions



The Stirling VAULT100 can operate as low as -100°C (-148°F). The following precautions are related to hazards working at such low temperatures and the impact it may have on sample storage materials.

- **CAUTION:** Frostbite can occur instantly at ULT Temperatures.
 - Do not handle samples or freezer accessories with bare hands.
 - Use only cryogenic gloves when handling materials at ultra-low temperatures.
 - Nitrile and latex gloves will become brittle and not provide adequate protection.
 - Permeable gloves allow frozen materials to contact skin and cause damage.
 - Be especially careful not to spill ultra-low temperature materials onto skin or clothing.
- **CAUTION:** Ultra-low temperatures may adversely impact sample containers.
 - Use only sample containers that have been approved or tested for ultra-low temperature use.
 - Do not use glass containers when the contents might expand on freezing to avoid splinter hazards.
 - Unapproved plastics may shatter at ultra-low temperatures and create splinter hazards.
 - Do not put ice or liquid water directly in the freezer cabinet; always use suitable containers.
 - Wear eye protection when handling materials that are stored at ULT temperatures.

2 OPERATOR SAFETY & PRECAUTIONS (Continued)

- **CAUTION:** Ultra-low temperatures may adversely impact sample labeling.
 - Use only sample label systems that have been approved or tested for ultra-low temperature use.
 - Many unapproved labels will fall off and/or break at ultra-low temperatures.
 - Unapproved ink may lose adhesion at ultra-low temperatures.
- **CAUTION:** Biological and chemical hazards are still hazardous at ultra-low temperatures.
 - Always wear proper protective equipment.
 - Always follow appropriate isolation protocols.
- **WARNING:** LN2 and CO2, commonly used in backup systems, are asphyxiants. Adequate ventilation must be maintained when using these systems.

2.4.2 Flammable Refrigerant Precautions



The Stirling VAULT100 uses a small amount of R-170 (Ethane) refrigerant hermetically sealed in its thermosiphon heat exchanger. R-170 is a flammable refrigerant so there is a risk of fire or explosion, but it is safe when the following precautions are taken.

- **WARNING:** Follow all safety labeling on the product related to flammable refrigerant.
- **WARNING:** Do not drill into or otherwise puncture the cabinet.
- **WARNING:** Refrigeration unit contains gas under high pressure. Do not tamper with or puncture the system. Service by qualified persons only. Contact qualified service personnel before disposal.
- **WARNING:** Component parts shall be replaced with like components and servicing shall be done by factory authorized service personnel to minimize the risk of possible ignition.
- **WARNING:** Take care moving and handling the unit to avoid damaging the refrigerant tubing and increasing the risk of a leak.
- **CAUTION:** Dispose of the unit properly in accordance with applicable regulations.

2.4.3 Tipping Precaution



The Stirling VAULT100's innovative design places the Stirling engine at the top of the freezer. This arrangement has a higher center of gravity than

ULT freezers with compressors on the bottom. The following precautions should be taken when moving the freezer. • **WARNING:** Raise the caster feet prior to moving the freezer.

- **WARNING:** Lower the caster feet with the freezer is in operation.
- **WARNING:** Remove the power cord from the unit before moving
- **WARNING:** When operated in earthquake zones, appropriate straps are necessary and are the responsibility of the user.
- **WARNING:** The unit should only be unpacked by persons experienced in appliance handling.
- **WARNING:** If the unit must be moved over uneven or unlevel floors, including ramps or door thresholds, then only persons with experience in appliance handling should do so.

2.5 GENERAL SAFETY PRECAUTIONS



Potential hazards associated with installation and maintenance of the Stirling VAULT100 may impact the safety of persons who install, maintain, and transport the freezer. All personnel who intend to perform these tasks should read the entire Operating and Service manuals to understand these hazards.

- **WARNING:** Refrigeration unit contains gas under high pressure. Do not tamper with or puncture the system. Service by qualified persons only. Contact qualified service personnel before disposal.
- **DANGER:** Risk of fire or explosion. Flammable refrigerant used. Do not use mechanical devices to defrost . Do not puncture refrigerant tubing.
- **WARNING:** Do not use mechanical devices or other means to accelerate the defrosting process, other than those recommended by the manufacturer.
- **WARNING:** Do not damage the refrigerant circuit,

In addition to the Operator Precautions described in section 2, read and understand these precautions related to installation and maintenance.

2.5.1 Environmental Precautions

- **WARNING:** Do not operate the freezer in a hazardous area. It is not rated for that application.
- **WARNING:** Ensure all ventilation openings are not obstructed.
- **CAUTION:** Do not allow the freezer to get wet at any time. Do not immerse in water, pour water on the unit, or locate where water may drip or fall on the unit.

2 OPERATOR SAFETY & PRECAUTIONS (Continued)

- **CAUTION:** Do not operate under extreme environmental conditions, outside of the limits listed in the Environmental Conditions section. Safety systems may be compromised.
- **CAUTION:** Do not block the air intake or exhaust vents.

2.5.2 Content Precautions

- **CAUTION:** Follow all instructions related to intended use.
- **WARNING:** Do not store flammable items such as gasoline, thinner, or solvents in the freezer. The freezer is NOT rated for Flammable Material Storage or as Explosion-proof.
- **CAUTION:** Disinfect with suitable sterilizing agent prior to handling if the freezer has been used for biohazards. Do not use bleach or abrasive cleaning pads.
- **CAUTION:** Do not exceed the maximum holding capacity of the shelves listed in the Specifications.

2.5.3 Maintenance Precautions

The tasks described in this section of the manual require special knowledge or training and are beyond the capability of typical users. Trained appliance maintenance providers are often capable of performing installation and maintenance tasks. If none are available, it is recommended to contact Stirling Ultracold, a Division of Global Cooling, Inc., for authorized service providers.

- **DANGER:** Risk of fire or explosion. Flammable refrigerant used. Do not use mechanical devices to defrost. Do not puncture refrigerant tubing.
- **WARNING:** Do not use mechanical devices or other means to accelerate the defrosting process, other than those recommended by the manufacturer.
- **WARNING:** Do not damage the refrigerant circuit.
- **WARNING:** Do not use hard and/or sharp objects, such as knives, screwdrivers, etc. to remove any ice or frost that has accumulated on the inside of the freezer. The inside panels are heat exchangers and can be damaged. Defrosting the cabinet is described later in this operating manual.
- **WARNING:** Disconnect power and allow stored energy to dissipate before removing top cover or hazardous live voltage will be exposed.
- **WARNING:** Wait 5 minutes after disconnecting power to allow stored energy to dissipate before removing cover or attempting to service the unit.



- **CAUTION:** Do not remove the power cord by pulling on the cable, instead grasp the plug firmly and pull away from the outlet.
- **CAUTION:** Do not attempt installation and maintenance tasks if you do not understand the hazards involved and do not have the training and experience necessary to perform them safely.
- **CAUTION:** Other than the inner doors, there are no user serviceable parts inside the freezer unit.



- **WARNING:** Using a non-rechargeable battery may cause the battery to release dangerous chemicals, rupture, and in extreme cases, catch fire.
- **WARNING:** Do not pitch the freezer more than 12 degrees from horizontal. Doing so may cause it to tip over.
- **WARNING:** Refrigeration unit contains gas under high pressure. Do not tamper with or puncture the system. Service by qualified persons only. Contact qualified service personnel before disposal.
- **CAUTION:** Freezer may leak water onto floor when defrosted, creating a slip hazard.
- **CAUTION:** Only use a power cord that is approved for use on the freezer and meets local codes and standards. Contact Stirling Ultracold Service or an authorized service provider before replacing the power cord.
- **CAUTION:** Do not cut, change, or modify the power cord.
- **CAUTION:** Do not modify the cabinet, controls or free-piston Stirling engine.*
- **CAUTION:** Component parts shall be replaced with like components.
- **CAUTION:** Disinfect with suitable sterilizing agent prior to handling if the freezer has been used for biohazards. Do not use bleach or abrasive cleaning pads.
- **CAUTION:** Operate only from a stable work platform when accessing the top of the freezer.
- **CAUTION:** Dispose of this unit properly in accordance with applicable regulations.
- **CAUTION:** Do not operate with top cover removed or irreparable damage to the Stirling engine will occur.*

***Doing so will void the warranty.**

2 OPERATOR SAFETY & PRECAUTIONS (Continued)

2.5.4 Service and Repair Precautions

- **DANGER:** Risk of fire or explosion. Flammable refrigerant used. Do not use mechanical devices to defrost. Do not puncture refrigerant tubing.
- **WARNING:** Operator should not attempt to remove the top covers or otherwise disassemble the freezer.*
- **WARNING:** Do not use mechanical devices or other means to accelerate the defrosting process, other than those recommended by the manufacturer.
- **WARNING:** Do not damage the refrigerant circuit.
- **CAUTION:** Unless otherwise indicated, there are no user serviceable parts inside the freezer unit.
- **CAUTION:** Do not modify the cabinet, controls, or free-piston Stirling engine.*
- **CAUTION:** Only authorized service providers may perform any repairs.
- **CAUTION:** Additional precautions, included in the service instructions, must be followed when servicing the unit.
- **CAUTION:** Component parts shall be replaced with like components.
- **CAUTION:** Dispose of this unit properly in accordance with applicable regulations.
- **CAUTION:** Follow handling instructions carefully.
- **CAUTION:** Do not operate with top cover removed or irreparable damage to the Stirling engine will occur.

* Doing so will void the warranty.

2.5.5 Mechanical Precautions



- **CAUTION:** Keep hands away from the door frame when closing to avoid injury.
- Be cautious when closing the door to avoid a pinching hazard.
- Be careful when loading the cabinet with heavy items.

2.5.6 Other Precautions



In addition to the safety precautions described above, there are additional precautions necessary to prevent damage to the freezer and extend its service life. The freezer itself may be damaged and/or its warranty voided by improper operation or usage.

- **CAUTION:** Ensure that all recommended maintenance is performed on schedule.
 - o Regular ice removal and gasket care are the most important actions operators can take to ensure the door operates and seals properly.
 - o Keeping the filter and engine warm fins clean will ensure the freezer continues cooling properly.
- **CAUTION:** Do not block the air intake or exhaust vents or the freezer will not cool properly.
- **CAUTION:** The freezer must be installed on a level surface to cool properly.
- **CAUTION:** Do not drill or puncture the cabinet liners when mounting earthquake straps or other accessories. This will likely result in irreparable damage to the insulation.
- **CAUTION:** Do not use solvents or abrasive cleaning pads to clean the panel or the outside/inside of the freezer.
- **CAUTION:** Unload the contents of the freezer before moving more than a short distance on smooth floors. The casters can be damaged if a loaded freezer is moved.
- **CAUTION:** ULT Freezers warm very quickly in the event of power loss or cooling failure and can lead to sample loss. Appropriate back-up and redundancy considerations are strongly encouraged.
- **CAUTION:** Do not operate with top cover removed or irreparable damage to the Stirling engine will occur.

3 FREEZER PICTORIAL TOUR

3.1 CABINET



- 1 Top covers
- 2 Mechanical compartment containing Stirling engine and control boards (not shown, covered by 2 top covers).
- 3 LCD, GUI, and flash drive connector
- 4 Outer door and gasket
- 5 Vacuum relief port
- 6 Lockable door handle
- 7 Air vent: Exit
- 8 Air vent: Intake
- 9 Air filter cover: Air filter installed inside
- 10 Magnetic latching inner doors
- 11 Electrical panel: Power cord and switch, Ethernet port, Dry contacts
- 12 Power cord strain relief clip
- 13 Electrical grounding stud (not shown, located on the top of cabinet, inside of top covers).
- 14 Access port and optional LN2/CO2 backup system port
- 15 Dual-wheel casters, leveling feet on front casters
- 16 Stainless steel shelves (shown with 5 shelves); Adjustable in 0.5" (12.7mm) increments.
- 17 Temperature sensor (RTD)
- 18 Cable conduit

3 FREEZER PICTORIAL TOUR (CONTINUED)

3.2 ELECTRICAL PANEL

Recessed Electrical Panel

- 1 AC Power Switch
- 2 AC Power Connector - Universal power input
 - o 120 to 240VAC at 50/60Hz, single phase
- 3 4-20 mA Terminal & Dry Contacts [See Section 7.2]
 - C - Common
 - NO - Normally Open, open during alarm
 - NC - Normally Closed, closed during alarm
 - G - Ground
 - (-) - Negative
 - (+) - Positive
- 4 Ethernet Port



3.3 ACCESSORY PANEL

Recessed Accessory Panel

- 1 Access port, with retained plug

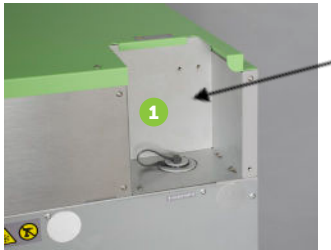

4 INSTALLATION AND SETUP PROCEDURE

Prior to installing your Stirling VAULT100, inspect the unpacked unit and any included items for shipping damage. Compare all contents to the Packing List (Section 4.3) for completeness.

4.1 INSTALLATION SITE QUALIFICATIONS

- 1 Be aware that the shipping packaging dimensions of 84 H x 43 D X 46 W in. (2134 x 1092 x 1168 mm) and shipping weight of 345 kg (760 lbs).
- 2 Be mindful when moving the shipment from the point of receipt to the place where it will be unpacked. The installation site must accommodate the freezer exterior dimensions of 1996 H x 871 D x 915 W mm (78.6 x 34.3 x 36 in.) and weight of 295 kg (650 lbs.).
- 3 There are no specific required clearances for the top and back of the freezer. However, allowances must be made for electrical connections to the panel on the back of the freezer.
 - The left side requires appropriate space for handle access and air venting.
 - The right side requires appropriate space for door opening and air venting.
 - A 4-in. clearance on both sides of the unit is recommended.
 - Never block the air vents to and from the mechanical compartment. The vents are located on the left and right sides of the freezer.
- 4 The access port must be plugged at all times for normal operation to avoid undue condensation, ice buildup, and air leakage. Ingress to the access port should remain clear during normal operation.
- 5 The freezer should be installed on a level surface. The leveling feet can accommodate small variations.
- 6 The facility/room lighting must not obscure the readability of the touch screen display (as with glare) and must provide good visibility for working with the contents of the freezer.
- 7 Care must be taken while unpacking and installing the freezer. Be mindful of its size and weight. Dropping the freezer is likely to damage it.



WARNING: Tipping Hazard—The unloaded freezer is TOP HEAVY. Use caution in moving and installation. DO NOT pitch the freezer more than 12 degrees from horizontal. Doing so may cause it to tip over.

4 INSTALLATION AND SETUP PROCEDURE (Continued)

4.2 EXTERNAL DIMENSIONS AND OPERATING FLOOR PLAN

Be aware that the shipping packaging dimensions 84 H x 43 D x 46 W in. (2134 x 1092 x 1168 mm) and shipping weight of 345 kg (760 lbs.).

The freezer should be set on a floor surface that is even and flat within 2 degrees slope. Slippery floor condition needs caution to secure freezer and to prevent moving from normal operation in door opening and closing.

4.3 INCLUDED ITEMS

- Quick Guide
- Port Sealant
- Dry Contacts Plug
- Two Keys
- Ice Scraper
- Wrench

4.4 UNPACKING



WARNING: Tipping Hazard—The unloaded freezer is TOP HEAVY. Use caution in moving and installation. DO NOT pitch the freezer more than 12 degrees from horizontal. Doing so may cause it to tip over.

RECOMMENDED TOOLS: Scissors and Phillips screwdriver

Step

Illustration

Instructions

1



Remove straps, plastic screws, top cardboard-frame, cardboard sides, foam, and utility bag from unit.

2



Remove wood lever and ramps from within pallet. Ensure all casters are oriented in the same direction and parallel to guide rail. Stow ramps somewhere accessible for step 6.

3



Use lever to prop-up unit.

4



While unit is propped, remove one corrugated cardboard buildup from underneath unit. Remove lever. Save the buildup for step 6.

4 INSTALLATION AND SETUP PROCEDURE (Continued)

5



Repeat steps 3 & 4 to remove the remaining corrugated cardboard buildup from underneath unit.

6



Set up ramps on side of pallet by lining up the brackets on the ramps with the notches on the pallet. Use both corrugated cardboard buildups and lever to add support to the ramps.

7



Carefully maneuver unit down the ramps using three to four people.

Upon receiving the unit, we advise you to properly dispose of any packaging material used to secure the unit during shipping. Please refer to local recycling codes and dispose of materials accordingly. For information on waste disposal sites, please refer to your local waste provider.

4.5 CASTERS/LEVELING FEET

When the freezer is located at user site, lower both leveling feet to secure the freezer on the floor so that the feet contact the floor by its weight and prevent movement from door opening and closing action using provided wrench.

4.6 MOVING THE FREEZER

To move the freezer to another location or temporarily place it into storage, perform the following steps:

1. Transfer the contents of the freezer to alternate storage. Refer to Safety precautions in this Operating Manual while making such transfers.
2. Shut down the freezer by turning off the power and allowing it to come to room temperature.
3. Dry the inside of the freezer compartment and clean any spills.
4. Disconnect wires and cables (including the power cord) connected to the freezer. See Setup for precautions associated with this task.
5. Disinfect with suitable sterilizing agent if the freezer has been used for biohazards. Do not use bleach or abrasive cleaning pads.

4 INSTALLATION AND SETUP PROCEDURE (Continued)

6. Close and secure the door to the freezer.
7. Raise the leveling feet using the supplied wrench before moving.
8. Move the freezer. See precautions associated with this task.

4.7 ACCESS PORT SETUP



The access port is located at the back of the freezer in the recessed accessory panel. The access port plug can be removed using the tab features and will remain tethered to the access port cap.

The access port must be plugged at all times for normal operation to avoid undue condensation, ice buildup, and air leakage. Ingress to the access port should remain clear during normal operation.



Thermocouple wires can be run to the interior through the unplugged access port. When doing so, use the supplied port sealant to seal around the wires on the access port cap.

4.8 ELECTRICAL POWER CONNECTION



The AC power connection is located at the back of the freezer in the recessed electrical panel. Ensure the power switch is OFF before installing or removing the power cord.

First, run the power cord through the loop clamp on the back-left of the freezer below the electrical panel. Then, insert the plug and secure it by lowering the retaining clip onto the neck of the plug. Finally, plug the power cord into an electrical outlet.

Do not remove the power cable by pulling on the cable. To remove, grasp the plug firmly and pull away from the outlet with the retaining clip up.

4 INSTALLATION AND SETUP PROCEDURE (Continued)

4.9 SETUP

1. Unpack freezer unit and included components, ensure all packaging material has been removed from around the fan inlet and outlet holes.
2. Move the freezer to the desired location (see Section 4.6) and adjust the leveling feet (wrench included) to secure the freezer in place.
3. Arrange and install the shelves as desired. See Section 9 for details. Each shelf has four clips – use the reference numbers on the pilasters to ensure that the clips are placed at the same height on each pilaster.



CAUTION: Maximum holding capacity of a shelf shall not exceed 68 kg (150 lbs.) evenly distributed.

4. Before switching ON electrical power to the freezer, make all desired external connections:
 - A. AC Power Connection (Secure the plug by lowering the retaining clip onto the neck of the plug once connected.)
 - B. If equipped with an external alarm, make all required connections.
5. Switch ON the AC power.
6. Ensure the access port plug is in place.
7. Review the date, time, and temperature setpoint via the GUI and adjust as needed. The default setpoint is -80°C (-112°F).
8. Initial PINs for Configurations and Service screens are described in Section 5.
9. Suppression of the temperature alarm allows for initial cooling of the freezer after start-up.
10. After the freezer reaches its operating temperature and its door is opened and closed, the partial vacuum created when warm air is admitted, then cooled, will prevent reopening of the door until the pressure is equalized. A vacuum relief port is provided to accelerate this process.
11. Be mindful of any electrical shock hazards associated with making electrical connections to the freezer, especially the external alarm connection.



5 OPERATION

5.1 GENERAL CONSIDERATIONS

Responsibility for freezer operation should be part of the policy and documented procedural guidelines for the clinic, laboratory, or other facility in which the freezer is used. Safety requirements are integral to these responsibilities.

Use this product only in the way described in the product literature and in this manual. Before using your Stirling VAULT100 verify that this product is suitable for its intended use. If this equipment is used in a manner not specified by the manufacturer, the equipment may be impaired.

5.2 POWER SWITCH & BATTERY OPERATION

The AC power switch is located at the back of the freezer above the AC power connection. The engine and electronics (including the GUI touchscreen) will automatically run in the ON position.

In the ON position, there is a 24-hour control battery back-up for the GUI touchscreen in the event of a power outage. The battery is recharged after power is re-established.

5.3 HANDLE OPERATION



Keep hands away from the door frame when closing to avoid injury.

The Stirling VAULT100 handle has been specifically designed for one-handed operation.

Open the Door

While facing the front of the freezer, pull the handle toward you and down to an angle of about 90°.

The Kickout-Release is designed to assist when the outer door is adhered to the gasket after long periods of non-use and when air pressure has not yet equalized. To engage the Kickout-Release, gently apply firm, downward pressure past the handle's open position.

Close the Door

Make sure the handle is still in the horizontal "open" position, push the door closed, and then return the handle to its original vertical position.

Lock the Door

Users may choose to utilize the keyed barrel lock on the handle with the included keys. Provisions for a padlock are included under the handle with holes to accommodate the lock.

5.4 GRAPHICAL USER INTERFACE

Accessible Values	Modifiable Values
> Current Freezer Temperature	> Temperature Setpoint
> Temperature History Chart	> Under Temperature Limit
> Alarm & Alert Status	> Over Temperature Limit
> Active Notifications	> Over/Under Temperature Alarm Delays
> Event Log	> Audible Alarm Silence Duration
> Connectivity Status	> External Contact Alarm Delay
> Freezer Run Hours & General Information	> Door Open Alarm Delay
> Stirling Ultracold Contact Information	> Maintenance Reminder Intervals
> Downloadable Data Files	> Gasket Heater Duty Cycle
> Predictive Analytics & Diagnostics	> Date & Time
> Engine Running Status	> Personal Identification Number (PIN)
> Freezer Running Status	> Network & Connectivity Settings
> Service Log (For Diagnostic Purposes)	> RTD Calibration Adjustments
	> Change Engine Serial Number
	> Change Freezer Serial Number

5 OPERATION (Continued)

5.4.1 GUI Menu

A hierarchical menu system is used to display and adjust system values. Each screen has the top-level menu options across the bottom bar for navigation. Each screen also displays freezer temperature, date and time, alarm/alert bell, and connectivity status. Here is the basic menu tree for reference:

HOME
SLEEP MODE
HOME & MENU
CHART
CHART - 12 HOURS
CHART - 24 HOURS
CHART - 7 DAYS
INFO
EVENT LOG
CONNECTIONS
DATA EXPORT
Exporting Data Files
Ejecting Flash Drive
CONTACT - STIRLING ULTRACOLD
ABOUT - FREEZER & RUN HRS INFO
ONBOARD PREDICTIVE ANALYTICS
PREDICTIVE ANALYTICS SUMMARY
Power
Motor
Piston
Reject
Thermosphiphon

CONFIGURATIONS
PIN ENTRY*
SETTINGS
Setpoint Temperature
Over Temperature
Under Temperature
Gasket Heater
Date/Time
ALARMS
Temperature Delay
Silence Duration
External Delay
Door Delay
Alarm Test
REMINDERS - HOME MENU
Battery Change Interval
Battery Change Due
Filter Change Interval
Filter Change Due
Ice Removal Interval
Ice Removal Due
Fin Service Interval
Fin Service Due
CONNECT
Connectivity Mode
Ethernet IP Address
BACnet ID
PIN - SETTING USER PIN

SERVICE
PIN ENTRY*
ENGINE
RTD Calibration
SYSTEM
SERVICE LOG
HARDWARE
Update Firmware
PIN - SETTING SERVICE PIN

*if PIN is enabled

Home – Temperature of internal chamber is viewable in full screen.

- > When the screen enters sleep mode (after 6 idle minutes), it will only display the temperature.
- > When the screen is tapped, the main menu icons are on the bottom bar and temperature & other status icons are on the top bar.

Chart – View the temperature history plotted over the last 12 hours, 24 hours, and 7 days. Data from the previous 52 weeks can also be viewed.

Info – View the following data and conduct data transfer to an external flash drive.

- > Event Log: Displays all recent events with dates and times.
- > Connections: View connectivity mode, IP address, and BACnet ID.
- > Data Export: Allows users to transfer data files to a flash drive.

- > Contact: Displays Stirling Ultracold contact information.
- > About: Displays various information including freezer model & serial number, engine serial number, power up & running hours, and firmware versions.

Onboard Predictive Analytics – Displays freezer and engine diagnostics by comparing predictive data to the freezer’s present data.

- > Power
- > Motor
- > Piston
- > Reject
- > Thermosiphon

Configurations – Allow adjustment of the following settings. If enabled, a PIN is required for entry.

- > Settings: Setpoint Temperature, Over Temperature, and Under Temperature, Gasket Heater Duty Cycle, and Date/Time
- > Alarms: Temperature Delay, Silence Duration, External Delay, and Alarm Test
- > Reminders: Battery Change, Filter Change, Ice Removal, and Reject Fin Service
- > User PIN: Reset the user PIN, enable the PIN, or disable the PIN.
- > Connect: Setting IP Address, Connectivity Mode, and BACnet.

Service – Technical data necessary for service and RTD calibration options. The service screen information is intended for use by authorized personnel only and can be set to require a service PIN.

- > RTD Calibration: Displays RTD readings and calibration offsets. Calibration is used to compensate for discrepancies between Display RTD and user-supplied temperature measurement.
- > Hardware Settings: If needed, this screen allows the firmware to be updated.
- > Service PIN: Allows the user to set a unique service PIN for accessing the SERVICE screen, distinct from the user PIN required for the CONFIGURATIONS screen. The service PIN can be disabled.



5.4.2 Basic GUI Controls

Follow these steps to change a value on the touchscreen of the GUI:





- > Tap on the appropriate button (e.g., Pencil icon) to edit the parameter.
- > Use the +/- buttons to enter the desired value.
- > Tap Save (Check Mark icon) to save your changes.

Note: Navigating away from any screen without tapping Save will abort any changes made on that screen and will revert the system back to the last saved value. *Be sure to tap Save whenever you want to keep changes.*

5.4.3 Guide to Basic GUI Functions

ON / OFF	Switch the main power on, located at the back of the unit above the AC cord.
Change Setpoint	Tap Settings  > Enter PIN* > Enter > Temperature > Setpoint > Temperature > +/- to adjust > Save
Silence Alarm	Tap the Mute icon in the bottom right corner.
Event Log	Tap Info  > Event Log > use scroll bar or \wedge/v arrows to view
Chart	Tap Chart  > Select Chart Type > use $\lt;/\gt$ to view

5.4.4 Guide to Advanced GUI Functions

Alarm Set-up	Tap Settings  > Enter PIN* > Enter > Alarms > Select Alarm Type > +/- to adjust > Save
Date and Time	Tap Settings  > Enter PIN* > Enter > Date / Time > Select Date/Time component > +/- to adjust > Save
Change User PIN	Tap Settings  > Enter PIN* > Enter > PIN > Enter New PIN > Enter > Re-enter New PIN > Enter
Change Service PIN	Tap Service  > Enter PIN* > Enter > PIN > Enter New PIN > Enter > Re-enter New PIN > Enter
Calibrate RTDs	Requires Authorized Service & PIN* Tap Service  > Enter Service PIN* > Enter > RTD Calibration > Cabinet RTD Offset > +/- to adjust > Save

*if PIN is enabled

5.4.5 Booting/Start-Up

When the power switch is in the ON position, the GUI automatically boots up and displays the below screen while the GUI operation system is booting up.



5.4.6 Home

The default Home & Menu screen is shown below. The six menu icons are centered across the bottom bar. From left to right, the menu items are Home, Chart, Info, Predictive Analytics, Configurations, and Service. When a menu is selected, the icon is highlighted in green.

The date, time and connectivity of the unit are displayed across the top bar.

Home & Menu



Sleep Mode



When the GUI screen is not touched for 6 minutes, it will enter Sleep Mode which only displays the freezer temperature.

5.4.7 Alarms & Alerts (Reminders)

The GUI displays Alarms and Alerts (reminders) in distinct ways.

Alarms are identified on the Home and Sleep screens by red banners across the top and bottom of the screen. An alarm bell is shown in the bottom left corner with the number of Alarms. Audible alarms will sound, and a Mute icon will appear in the bottom-right corner. Select this icon to temporarily silence the alarms for a set duration.

Home & Menus - Alarms

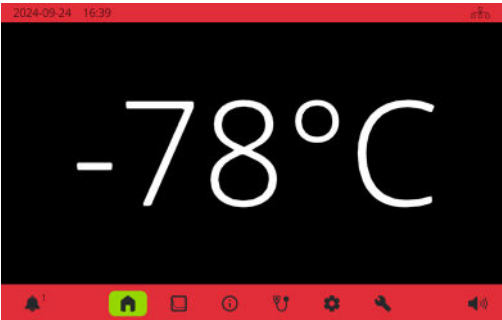

Sleep Mode - Alarms



Alerts are identified on the Home screen by yellow banners across the top and bottom of the screen. An alert bell shows the number of alerts in the bottom left corner.

Home & Menus - Alerts



Sleep Mode - Alerts



Tapping the alarm/alert bell leads to an Active Notifications screen. Alarms are displayed with a red indicator; alerts have a yellow indicator.

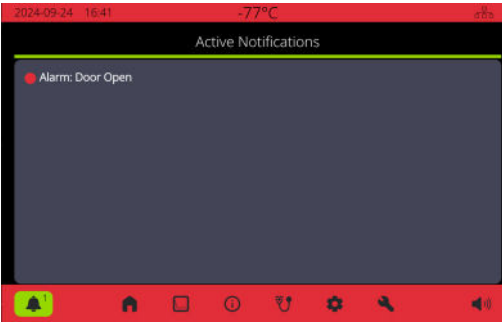

Alarm Descriptions

The Stirling VAULT100 is equipped with several alarm codes that display when applicable on the freezer's GUI screen. Freezer alarms are accompanied by an audible sound in the unit enclosure and can be connected to an external alarm. The GUI provides settings that allow the user to temporarily suppress or delay alarms. Alarms are identified on the Home screens by red banners across the top and bottom of the screen, and an alarm bell in the bottom left corner.

Events & Alarms
Over temperature alarm delayed due to high temperature power up
Door Open/Door Closed
Freezer RTD calibration changed from -0°C to -0.6°C
User changed time
Freezer setpoint changed from %d °C to %d °C
Freezer at setpoint +/--1°C
Service Technician replaced battery
Filter replaced
Ice removed from gasket
Service Technician cleaned reject fins
User/Service PIN changed
Freezer over/under temperature
Line Power failure/Power restored
Freezer/Cold-head RTD fault/corrected
Warm-head thermistor fault/corrected
Engine fault
Inverter fault
Battery fuse fault/fault cleared
Battery not connected/reconnected

5.4.8 Chart

Temperature (y-axis) vs. time (x-axis) charts for the last 12 hours, 24 hours, and 7 days are viewable under the Chart icon. Temperature (green), Door Openings (light blue), and power failures (yellow) are plotted on the charts. The left/right arrow icons can be used to view the previous 52 weeks.

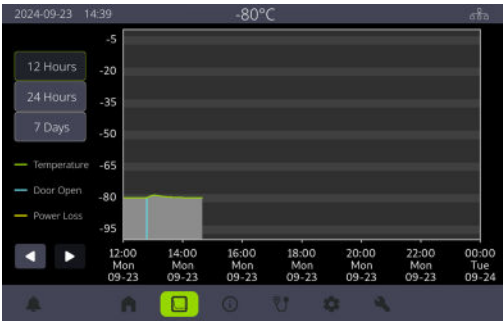

5 OPERATION (Continued)

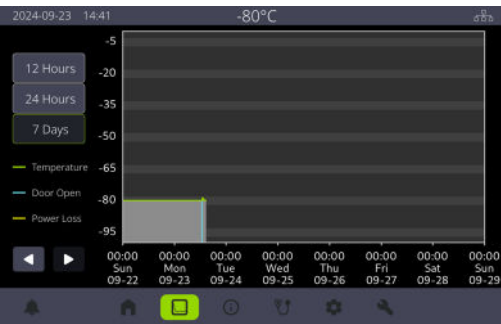
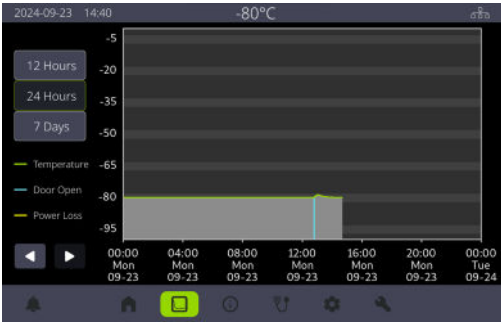

5.4.9 Information

The Information menu includes five tabs: Event Log, Connections, Data Export, Contact, and About.

Event Log screen displays all events. Slide up/down on the touchscreen to navigate.

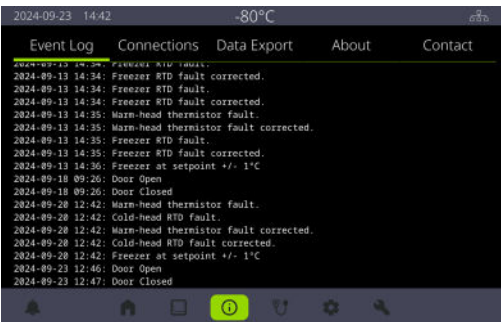

5 OPERATION (Continued)

Connections screen displays the connectivity mode, IP address, and BACnet ID.

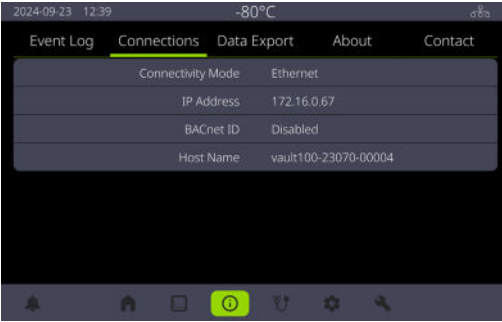

Contact screen displays contact information for Stirling Ultracold.

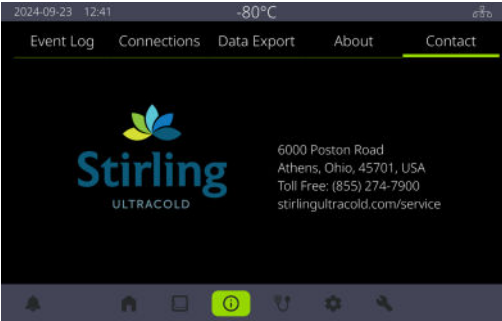

About screen displays general information including freezer mode, freezer serial number, engine serial number, power up & running hours, and firmware versions.

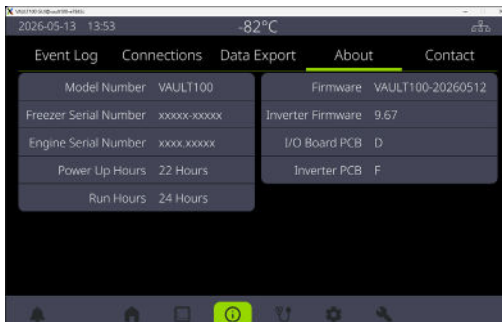

5 OPERATION (Continued)

Data Export screen can be used to export data to a flash drive. It first prompts the user to insert the flash drive and then gives options to Export Data Files and Eject Flash Drive. When removing the flash drive, wait until the screen says it is safe to remove before doing so.

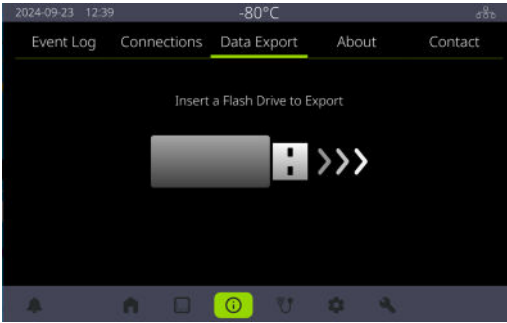

5.4.10 Onboard Predictive Analytics

The Predictive Analytics menu allows users to monitor the health of their freezer. Key charts are tracked under five tabs: Power, Motor, Piston, Reject, and Thermosiphon. Each tab uses predictive data compared to the freezer's current data to display diagnostic information.

The freezer run time and operating temperature are used to analyze the various parameters. Each chart includes initial operating conditions, current operating conditions, and ranges for the expected operating conditions. The current conditions are compared to the expected ranges (healthy zones) to give diagnostics.

A summary screen displays the freezer's health condition and the date & time at which the analysis was performed. Navigating to the Predictive Analytics menu will prompt this summary message - tap the screen to dismiss.

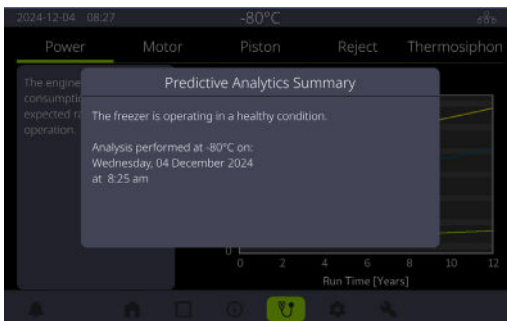

5 OPERATION (Continued)

Power: Charts Engine Power (Watts) vs. Run Time (Years) to determine if the engine power consumption is within the expected range.

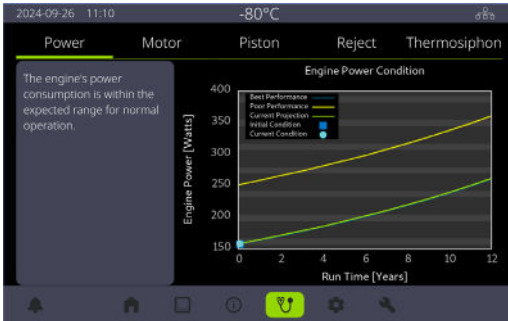

Motor: Charts Motor Power Factor vs. Freezer Operation Temperature (°C) to determine if the engine motor is operating under expected conditions.

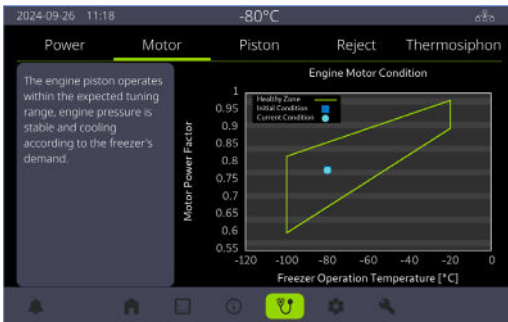

Piston: Charts Piston Displacement (mm) vs. Freezer Operation Temperature (°C) to determine if the engine piston movement is within the expected range.

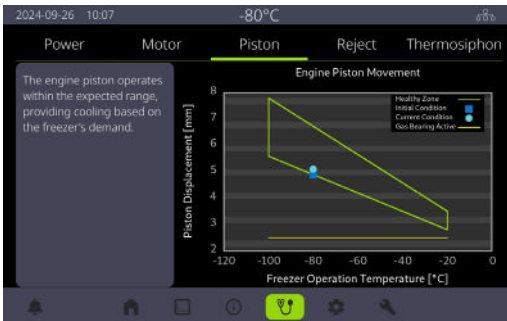

5 OPERATION (Continued)

Reject: Charts Thermistor Temperature Increase (°C) vs. Run Time (Years) to determine if the heat rejection performance is within the expected range.



Thermosiphon: Charts Thermosiphon Temperature Change (°C) vs. Run Time (Years) to determine if the thermosiphon is operating normally.

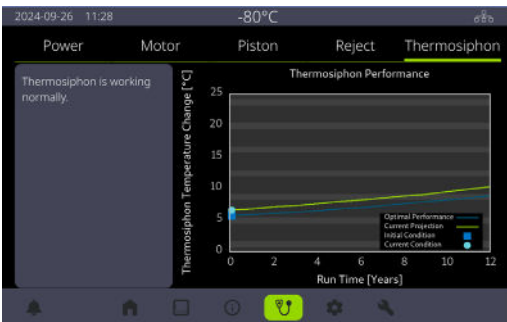

5 OPERATION (Continued)

5.4.11 Configurations

The Configurations menu includes five tabs: Settings, Alarms, Reminders, Connect, and PIN.

If enabled, the User PIN must be entered to access the Configurations Menu.

Settings screen allows users to change Setpoint Temperature (-100°C to -20°C), Over Temperature (+4°C to +20°C), Under Temperature (-20°C to -4°C), Gasket Heater Duty Cycle, and Date/Time.

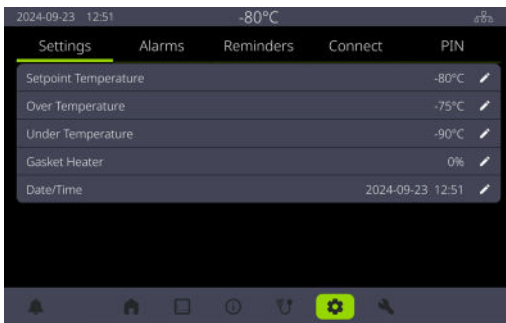

Gasket Heater screen allows users to change the gasket heater duty cycle from 0% to 100%. Increase the percentage for more defrost heating when there is ice buildup around the door.

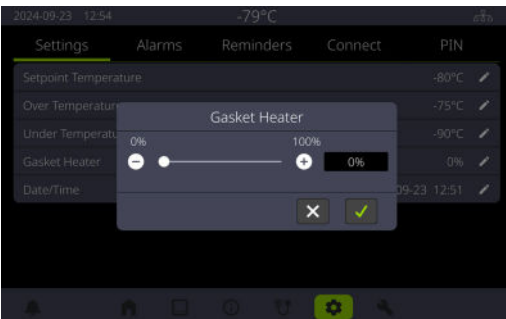

Date/Time screen allows users to change the freezer's date and time.

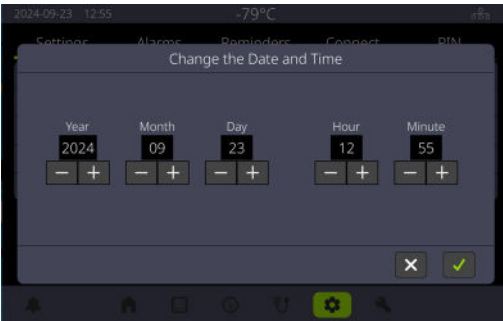

Alarm screen allows users to change alarm settings:

- **Temperature Delay** (1 min. to 120 min.): Delay time for over and under temperature alarms.
- **Silence Duration** (1 min. to 120 min.): Length of time the audible alarm is silenced when the Speaker icon is tapped.
- **External Delay** (0 min. to 120 min.): Delay time for sending alarm to an external device through dry contacts.
- **Door Delay** (1 min. to 10 min.): Delay time for door open alarm.
- **Alarm Test**: Allows users to test audible and dry contact alarms.



5 OPERATION (Continued)

Reminder screen allows users to change time intervals for various maintenance tasks and reset the due date when tasks are completed. The following can be changed:

- **Battery Change Interval** (12 months to 36 months)
- **Filter Change Interval** (1 month to 12 months)
- **Ice Removal Interval** (1 week to 12 weeks)
- **Reject Fin Service** (6 months to 24 months)

To reset the due date after completion, select the task from the right column and hold to update. The due date will then be updated based on the set interval.



Connect screen allows users to set up the IP address, Connectivity Mode (wired or wireless), and BACnet.

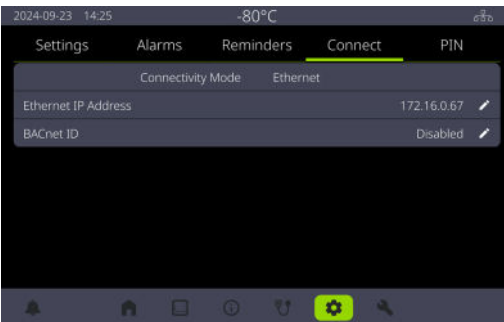

PIN screen allows users to set a 1-to-5-digit PIN that is required for entering the Settings Menu. After entering the new PIN once, the user will be prompted to re-enter the PIN to confirm. **If users go through the process without entering any numbers, the PIN will be disabled and will not be required to enter the Settings menu.**

5 OPERATION (Continued)



5.4.12 Service

Engine and **System** display key operation parameters to help service diagnostics.

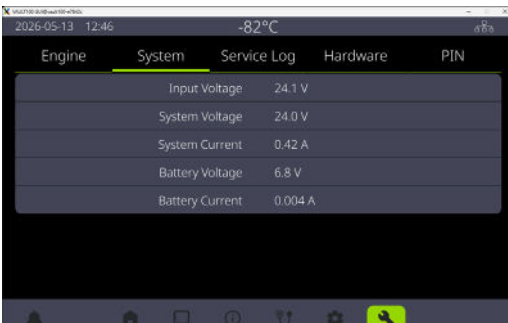

RTD Calibration Screen is used to compensate for discrepancies between the Display RTD and a user provided standard. This screen requires Authorized Service & PIN, if enabled.

5 OPERATION (Continued)

The RTD Calibration screen displays the current RTD offset and the last calibration date. The RTD offset range is -5°C to $+5^{\circ}\text{C}$. The new cabinet temperature is shown when editing the RTD offset.

The RTD may be calibrated by inserting a temperature sensor through the access port and securing it next to the RTD. Follow these instructions for best results:

- Insert a temperature sensor through the access port in the back of the cabinet. Do not insert the wires through the doors as the gap in the gasket will negatively affect the RTD.
- For access to the RTD, it may be necessary to transfer the contents of the freezer to alternate storage. Refer to the safety precautions in Cleaning when making such transfers.
- Navigate to the RTD Calibration screen and edit the Cabinet RTD Offset. These screens require Authorized Service & PIN, if enabled.

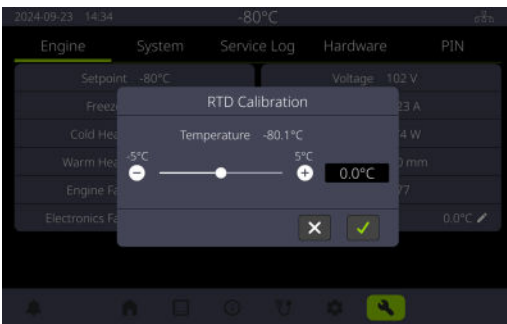

Service Log displays specific data regarding control parameters that are used for more complex diagnostics.

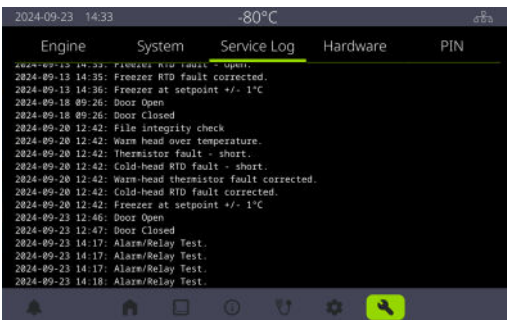

5 OPERATION (Continued)

The Hardware screen allows for updating of the firmware and displays hardware information for the freezer. A hardware key is required for some options and requires an authorized service provider.

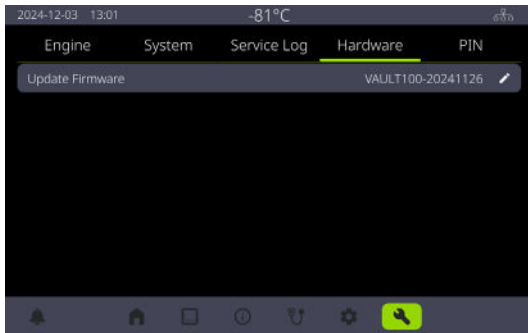

PIN screen allows users to set a 1-to-5-digit PIN that is required for entering the Service Menu. After entering the new PIN once, the user will be prompted to re-enter the PIN to confirm. If users go through the process without entering any numbers, the PIN will be disabled and will not be required to enter the Service menu.

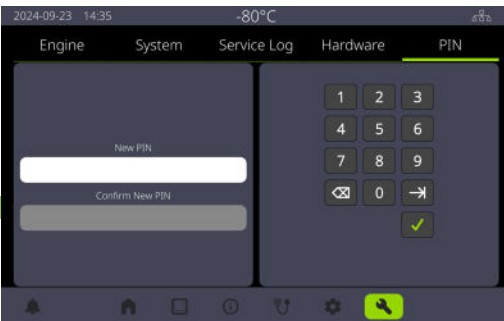

The Stirling VAULT100 freezer is designed for long-term storage of sample materials with ultra-low, well-regulated temperature storage requirements.

- The temperature setpoint for the freezer should be changed appropriately for the materials being stored using the Graphical User Interface (GUI) – adjust the high and low temperature limits as necessary.
- The freezer temperature is displayed on the Home screen and in the banner of all screens. A temperature history chart is available within the Chart menu.

5 OPERATION (Continued)

- Materials may be placed in the freezer in any convenient arrangement that does not block the access port, interfere with the door gasket, or prevent the door from closing completely.
- For best results, operate freezer at full capacity with real or simulated product to increase the thermal mass, displace air, and maintain optimal stability.
- Please review the Operator Safety and Precautions section of this manual.

6 MAINTENANCE

6.1 PREVENTATIVE MAINTENANCE SCHEDULE

The Stirling VAULT100 freezer is designed for years of trouble-free operation. To prevent costly and inconvenient repairs, and to maintain your freezer at an optimum level of performance, follow the recommended preventative maintenance schedule and contact an authorized service provider as needed.

6.1.1 Monthly Maintenance List

- De-ice Gaskets and Breaker
 - > Remove any frost buildup from around door, door gaskets, and breaker using the provided scraper or a soft cloth.
- Inspect Vacuum Relief Port
 - > The Vacuum Relief Port is designed to remain frost-free, preventing clogging from frost or ice over long periods of use. If you notice frost or ice around the port, clear it using the provided scraper.



6.1.2 Yearly Maintenance List

■ Check and Clean Reject Fins

To be performed only by an authorized service provider.



CAUTION: High Voltage hazard - performed by authorized service provider only.



CAUTION: Cover is in two parts and together weighs approximately 17 lbs.

■ Air Filter Replacement

Recommend air filter replacement every 6 months.

- > Turn the power switch OFF.
- > Remove air filter cover by using a screwdriver or turning thumb knobs manually.
- > Replace air filter and reinstall air filter cover.
- > Turn power switch ON.



6 MAINTENANCE (Continued)

6.1.3 Biennial Maintenance List

To be performed only by an authorized service provider.

■ Replace Battery



CAUTION: Only use a sealed lead acid rechargeable battery (6V, 36Ah) as specified. Power-Sonic (PS-6360 F2) replacement batteries can be purchased from Stirling Ultracold (Part # SD-520103).



WARNING: Risk of fire or explosion. Using a non-rechargeable battery may cause the battery to leak or explode, and in extreme cases, the battery may burst into flames. Non-rechargeable batteries contain dangerous chemicals, which may escape if used, causing serious health hazards.



CAUTION: Stored Voltage hazard - performed by authorized service provider only.



CAUTION: Cover is in two parts and together weighs approximately 17 lbs.

■ Power Cord Replacement



CAUTION: Contact Stirling Ultracold Service or an authorized service provider before replacing mains/power cord. Cord must be rated at a minimum of 250V and 12A. Cord must be approved by the following agencies: UL and CSA. If the freezer's voltage rating does not match your mains/electrical supply, or if the plug on the mains/power cord does not fit the outlet, do not plug in the freezer.

6.2 OPERATOR MAINTENANCE

6.2.1 Cleaning and Disinfection

Clean the exterior surfaces of the Stirling VAULT100 cabinet as needed by using a soft cloth and mild detergent. Do not use solvents (such as bleach) or harsh abrasive cleansers or pads.

6 MAINTENANCE (Continued)

6.2.2 De-Ice Gaskets and Breaker

Remove any frost buildup from around door, door gaskets, and breaker using the provided scraper or a soft cloth.

In the event of excess ice accumulation, remove any ice that accumulates inside the freezer by defrosting it. Refer to the Operator Safety and Precautions section of this Operating Manual when defrosting the freezer.

- Transfer the contents of the freezer to alternate storage, switch off the power to the freezer and wait for the ice to melt.
- Wipe up moisture with a clean cloth. If the freezer door can be left ajar safely, defrosting will be more rapid.
- After defrosting the freezer, close door and switch the power back on. When the temperature reaches the setpoint, return the contents to the freezer.
- Clean ice from the Vacuum Relief Port on the inside of the outer door. If ice clogs the port, it may require an extended period before the door can be reopened after the initial opening.

6.2.3 Inner Door Replacement

Inner Doors can be replaced without using a tool. While replacing an Inner Door, the freezer can run without switching the power off. Please wear gloves to prevent any risk from freezer burn.

- Open Inner Door about 45-90°.
- Hold Inner Door with left hand and tap the bottom of the Inner Door with right hand at hinge side. It will disengage keyhole standoffs from the hinge leaf and allow the Inner Door to be removed.
- Install new Inner Door by engaging all 4 keyhole standoffs to the slots.



7 REMOTE MONITORING

7.1 BACnet

BACnet is available to provide freezer information via the Building Automation and Control Networking Protocol to the customer's Building Management Software Platform. For details on how to configure the freezer please refer to the Building Management Software Platform and its software administrator.

7.2 DRY CONTACTS

The dry contacts for external alarm connections are located at the back of the freezer at the top of the electrical panel:

- Dry Contacts [NC : NO : C]
 - > C - Common ⑥
 - > NO - Normally Open, open during alarm ⑤
 - > NC - Normally Closed, closed during alarm ④

Turn the freezer off before installing or removing any connections – see Setup (Section 4.10) and the Operator Safety and Precautions section of this Operating Manual.

All operators/installers must test the dry contact outputs after installation. See 'Alarm Test Configuration' in Appendix A, section A2.



7.3 4-20MA (OPTIONAL)

Contact Stirling Ultracold Service or an authorized service provider to install an optional 4-20mA external monitoring system.

- 4-20 mA Terminal [(+) : (-) : G]
 - > G - Ground ③
 - > (-) -Negative ②
 - > (+) - Positive ①

Turn the freezer off before installing or removing any connections – see Setup (Section 4.10) and the Operator Safety and Precautions section of this Operating Manual.

8 BACKUP SYSTEMS



WARNING: LN2 and CO2, commonly used in backup systems, are asphyxiants. Adequate ventilation must be maintained when using these systems.

8.1 LN2 BACKUP SYSTEM (OPTIONAL):

Contact Stirling Ultracold Service or an authorized service provider to install an optional LN2 Backup System.

8.2 CO2 BACKUP SYSTEM (OPTIONAL):

Contact Stirling Ultracold Service or an authorized service provider to install an optional CO2 Backup System.

9 SAMPLE MANAGEMENT AND RACKING

9.1 GENERAL PRECAUTIONS

For safety and to prevent surface scratches, take precautions when removing or adjusting shelves and pilaster clips to different positions.

When inserting racking systems, take precautions to ensure safety and prevent surface scratches.

Racking systems need to be inserted deep enough so that inner doors are fully seated without contacting racks or rack handles.

9.2 AVAILABLE STORAGE VOLUME WITHOUT SHELVES

The maximum storage volume available for a high-density racking system is 28.8" Width (pilaster to pilaster clearance), 27.8" Depth (inner door to back wall clearance), 60.7" Height (top and bottom clearance), without shelves.

Refer to Stirling Ultracold Rack Solutions catalog – contact Stirling Ultracold sales for details.

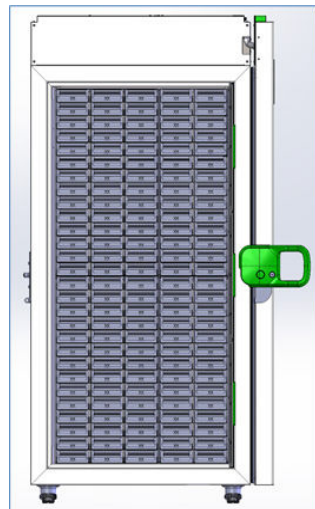
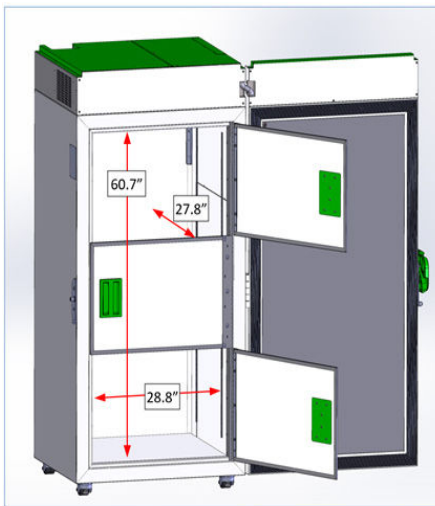

High Density Rack
(780-HD2-700) installed
storage: 700 2" boxes

9.3 AVAILABLE STORAGE VOLUME WITH SHELVES

Storage space can be adjusted for various racking systems by changing the shelf positions. The clearance between shelves for the standard shelf position is illustrated below. This is for typical storage of 600 2" boxes. The standard shelf positions allow each inner door to access 2 compartments without interference from the other inner doors.

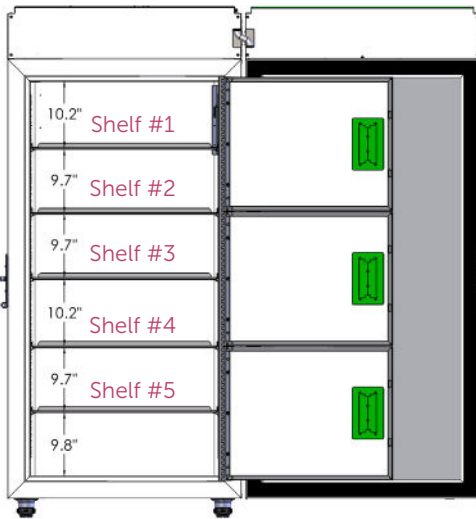

- 5 Shelves, 6 Compartments
 - > Storage: 600 2" boxes
 - > Storage: Mix of 2" and 3" boxes
- One inner door to access 2 compartments.

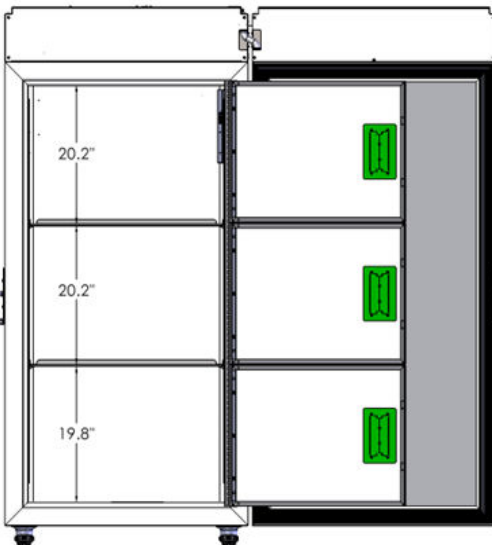

- 2 Shelves, 3 Compartments
 - > Storage: Custom size racks
- One inner door to access 1 compartment.



The shelves are adjustable in 0.5" (12.7 mm) increments. After removing a shelf, the four clips can be moved to different positions on the four pilasters. To remove a clip, push up near the bend and then pull outwards. Each clip has two tabs to be inserted into the pilaster holes. When adjusting the clips, use the reference numbers marked on the pilasters to ensure that all four clips are at the same height.

The following shows the clip positions for the standard shelf position based on the pilaster rivet locations and the reference numbers.

Pilaster Clip Position for Standard Shelf #2

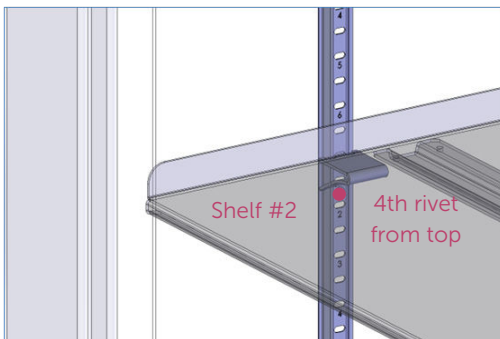

9 SAMPLE MANAGEMENT AND RACKING (Continued)

- Located above the 4th rivet from the top
 - > The flat section of the clip is inserted in slot #1
 - > The angled section of the clip is inserted in the slot between slots #1 and #2
- The top inner door is used to access shelf #2

Pilaster Clip Position for Standard Shelf #1

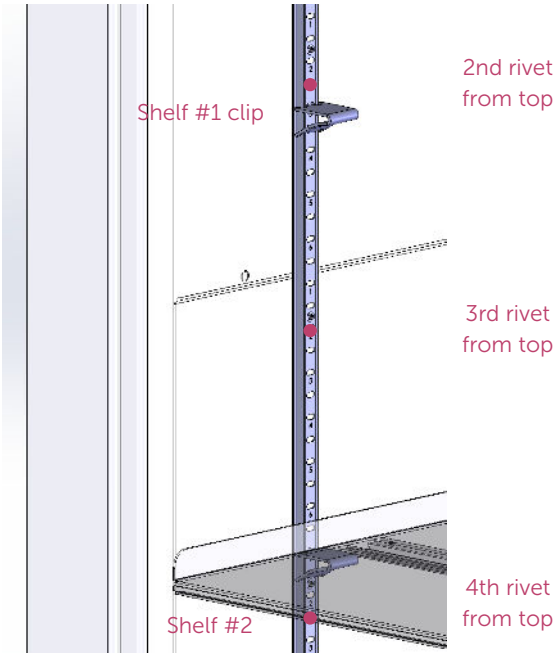

- Located below the 2nd rivet from the top
 - > The flat section of the clip is inserted in slot #3
 - > The angled section of the clip is inserted in the slot between slots #3 and #4.
- The top inner door is used to access shelf #1

Pilaster Clip Position for Standard Shelf #4

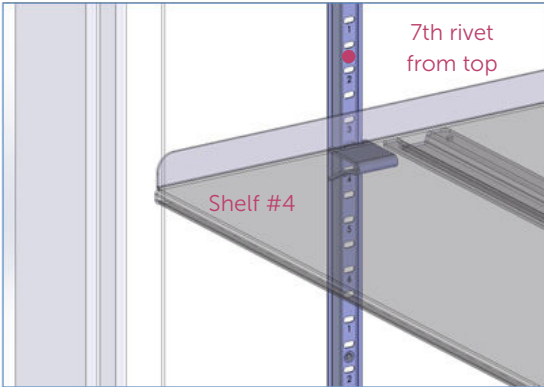

- Located above the 7th rivet from the top
 - > The flat section of the clip is inserted in the slot between slots #3 and #4
 - > The angled section of the clip is inserted in slot #4
- The middle inner door is used to access shelf #4

Pilaster Clip Position for Standard Shelf #3

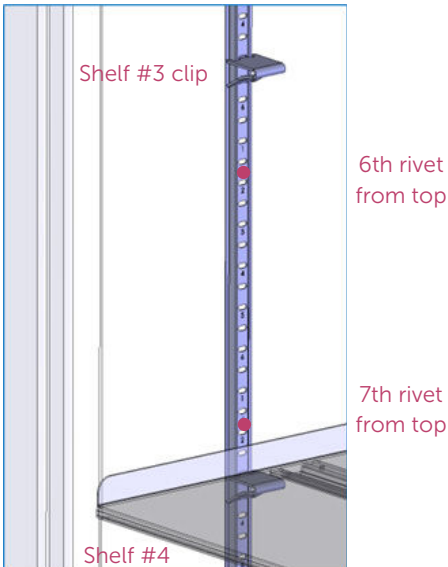

9 SAMPLE MANAGEMENT AND RACKING (Continued)

- Located above the 6th rivet from the top
 - > The flat section of the clip is inserted in slot #5
 - > The angled section of the clip is inserted in the slot between slots #5 and #6
- The middle inner door is used to access shelf #3

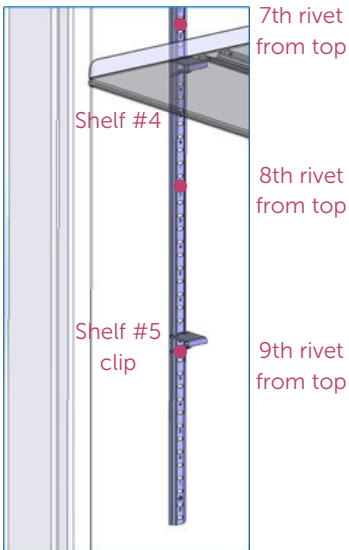

Pilaster Clip Position for Standard Shelf #5



- Located at the 9th rivet from the top
 - > The flat section of the clip is inserted in the slot between slots #1 and #2
 - > The angled section of the clip is inserted in slot #2
- The bottom inner door is used to access shelf #5

10 SPECIFICATIONS

Note: Specifications are subject to change without notice. Refer to stirlingultracold.com for the latest specifications.

Item	Specification
Electrical Power	120 - 240 VAC at 50/60 Hz
Maximum Power (Current)	1200 watts (10 amps @120 V, 5 amps @240 V), nominal
Electrical Supply Rating	15 amp or greater grounded circuit
Cooling Engine	R704 (Helium) charged free-piston Stirling engine 10 g, (0.35 oz)
Heat Transport System	Gravity-driven thermosiphon
Thermosiphon Refrigerant <i>Risk of fire or explosion.</i> <i>Flammable refrigerant used.</i> <i>Do not drill or puncture inner liner.</i>	R-170 (Ethane) HFC/HCFC-Free, 90 g (3 oz) <i>To be repaired only by authorized service providers. Component parts shall be replaced with like components.</i> <i>Consult Service Manual before attempting to service this product. All safety precautions must be followed. Dispose of properly in accordance with applicable regulations.</i> <i>Follow handling instructions carefully.</i>
 	
Temperature Range	-100°C (-148°F) to -20°C (-4°F), adjustable in 1°C increments
Ambient Operating Temperature	+5°C to +35°C (41°F to 95°F)
Warehouse Storage Temperature	-5°C to +60°C (23°F to 140°F) at RH 65%
Operational Environment	This ultra-low temperature freezer is designed for use in a normal laboratory environment. Avoid unusual dust or particulate circulation.
Useful Life	15 years, nominal
Storage Volume	795 L (28 cu. ft.)
Interior Dimensions	1542 H x 706 D x 732 mm W (60.7 x 27.8 x 28.8 in.)
Exterior Dimensions	1996 H x 871 D x 915 mm W (78.6 x 34.3 x 36 in.)
Net Weight, 5 Shelves (No Load)	295 kg (650 lbs.)
Shelf Load Capacity	Maximum 68 kg (150 lbs.) per shelf, evenly distributed

Maximum Loading Capacity	680 kg (1,500 lbs.)
Insulation	High performance vacuum-insulated panels and polyurethane foam using the Ecomate® environmentally friendly, SNAP-compliant blowing agent
Noise	< 42 dB(A) at 1 meter from front of freezer in steady state operation
Current Fuse	Maximum current is 10 Amps at 120 V. No surge current occurs at start and stop (5mm x 20mm 12.5A 250VAC Fast-Acting)
Control Sensor	One RTD (PT100 Class A)
Dry Contacts	Normally Closed, Normally Open, and Common; activated by power outage or any alarm condition.
Battery Back-Up	24-hour battery back-up for touchscreen and temperature display

Dimensions

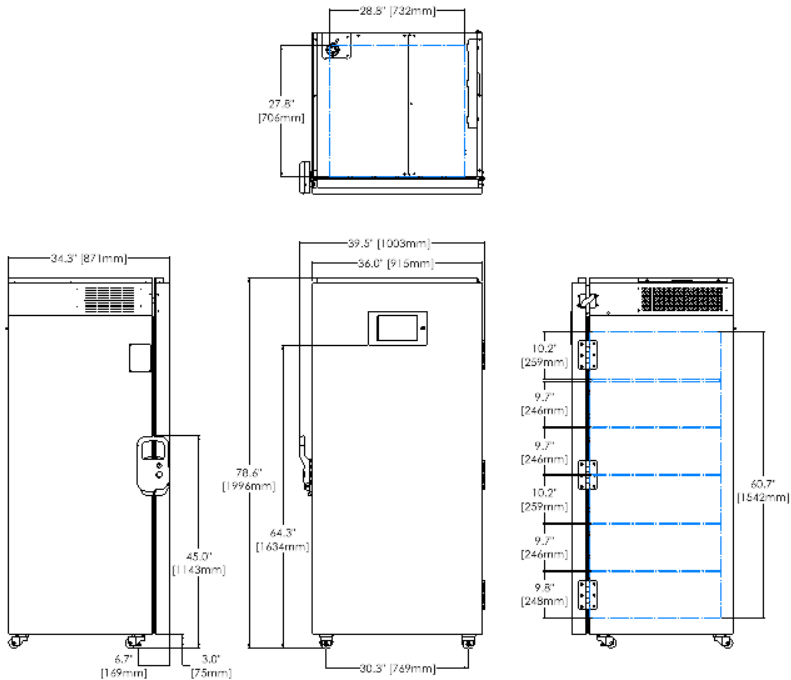

10 SPECIFICATIONS (Continued)

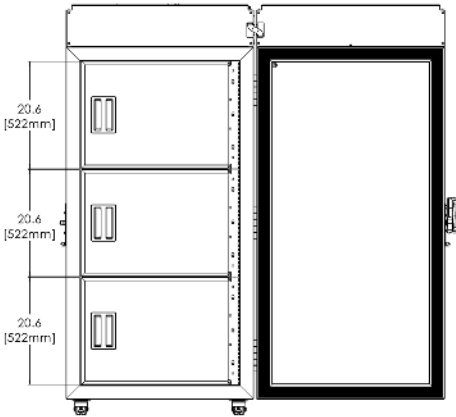

10.1 PERFORMANCE DATA

Energy Use*	6.25 kWh/day at -75°C (-103°F) 0.22 kWh/day/cu-ft
Steady State Energy Use (Without Door Opening)	4.8 kWh/day at -70°C (-94°F) 5.3 kWh/day at -75°C (-103°F) 5.8 kWh/day at -80°C (-112°F)
Pull-Down from Ambient (24~25°C)	5.5 Hours @ Ambient to -80°C (-112°F)
Recovery from Door Opening *	26 Minutes at -80°C
Warm-Up Profile from -80°C	3.8 hours to -60°C (-76°F) 9.3 hours to -40°C (-40°F) 17.0 hours to -20°C (-4°F)
Heat Dissipation (Load to HVAC)	754 Btu/h @ Steady state at -75°C 889 Btu/h @ 6 door-openings at -75°C

*ENERGY STAR® Final Test Method “weighted average”

Pulldown & Temperature, Warmup Profile

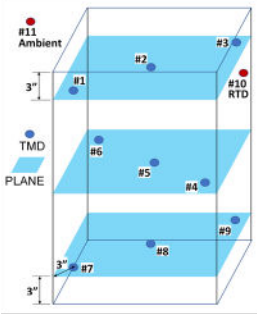
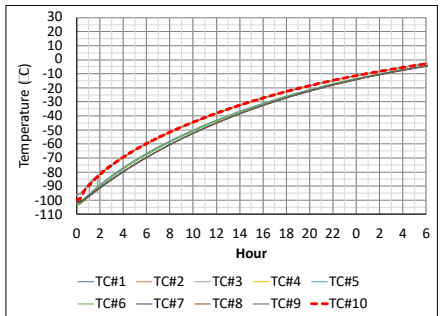
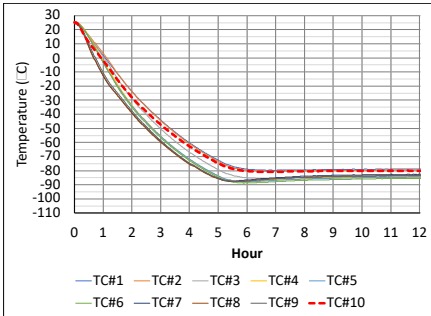

10.2 MATERIAL SPECIFICATIONS

Part	Material	Color	Treatment
Body: Main Body, Door, Front Cover, and Top Cover	Mild Steel	White/Gray/Green	Powder Coated
Interior	Mild Steel, Aluminum	White	Powder Coated
Shelves	Stainless Steel	Silver	Natural
Handle	Zinc Alloy	Green	Powder Coated
Hinges	Steel	White	Powder Coated
LCD Bezel	ABS	Black	Injection Molded
Conduit (Cable Routing*)	Stainless Steel	Silver	Natural

11 TROUBLESHOOTING

Problem	Possible Cause(s)	Potential Solutions
Freezer does not power ON	Power is not getting to the freezer from the Power Supply	Check the connections of the AC/mains cord.
		Ensure that the power cord is firmly seated in the back of the freezer (with the retaining clip) and in the outlet on the wall.
Chamber temperature does not reach the desired setpoint	Large amount of warm product added at once	Allow freezer an extended period (up to 2-3 hours) to fully recover.
	Extended door opening	
	Heat rejection fins are dirty	Contact Service to clean engine fins.
	Inadequate air circulation in the engine/electronics area of the freezer	Make sure air intake/exit fans are operational and air intake (hinge side with filter) and exit vents (handle side) are not blocked.
Replace air filter on the freezer, if necessary.		
Freezer recovers/ returns to set point slowly	Door is not completely closed	Check for ice buildup, remove if necessary, and properly close door.
	Door is open and closed too often	Minimize opening and closing of door and minimize time the door is open.
	Inadequate air circulation	Unblock air intake (hinge side with filter) and exhaust vents (handle side). Change air filter.
	Ambient air temperature above 35°C	Ensure ambient air conditions are cooler than 35°C.
Too much frost buildup along gasket and/or inside freezer	Door not properly sealed	Ensure gasket is clean and free of debris and ice. Even a small gap will quickly allow the moisture in the air to turn into ice.
		Make sure inner doors can close completely to allow outer door to shut and seal.
	Gasket heater duty cycle not high enough	Increase duty cycle of gasket heater if ice is building around door due to high ambient humidity.

Door does not open after recent opening	Vacuum relief port is clogged with ice	Allow time for air pressure to equalize inside of chamber – up to 5 minutes.
		Clear ice from port and apply vacuum-relief grease to prevent future ice buildup.
Freezer is not cooling – Display on door is ON	Power line cord is disconnected or not properly installed* on freezer	Plug approved power cord into connection on the back of the freezer and secure with attached retainer clip.
	AC/mains circuit breaker is tripped or open*	Test AC/mains outlet for power. Reset circuit breaker if power is not present.
	Engine failure Loss of refrigerant in thermosiphon	Call Service immediately.
When freezer is at desired temperature – Door cannot be opened for a long duration after an initial door opening	Vacuum relief port may be clogged with ice	Clean ice from port on inside of door to ensure fastest air exchange.
		Allow sufficient time for air to return to chamber after a door opening (>5 minutes).
Freezer is not cooling – Display on door is OFF	Main power switch on back of freezer is OFF	Switch ON the main power.
	Battery backup in freezer is discharged, and unit is not connected to AC/ mains	Plug approved power cord into AC/ mains, switch ON power, and allow battery backup to recharge.

* Stirling VAULT100 is equipped with a battery backup to maintain display in the event of power loss.

12 WARRANTY

The following Warranty applies to the Stirling VAULT100 (the "Unit") manufactured by Global Cooling, Inc. In order to maintain maximum uptime and to optimize customer

service, Global Cooling, Inc. reserves the right to exchange the Unit with a serviceable new or previously used replacement at its discretion.

LIMITED WARRANTY, USA

- The warranty periods contained herein start **TWO WEEKS** after the original date of shipment from Global Cooling, Inc.
- The Stirling Ultracold freezer is warranted for a full **SIX YEARS** for all labor and parts, including the Stirling engine and thermosiphon.
- If a service issue arises, contact Global Cooling, Inc. Service Department to register Warranty Service and initiate a resolution.
- Advanced authorization for a service company to diagnose the problem must be approved by Global Cooling, Inc.
- Global Cooling, Inc. will not be responsible for charges incurred for service calls made by a third party prior to authorization by Global Cooling, Inc.
- Global Cooling, Inc. retains the right to replace the Unit in lieu of servicing it in the field.
- Liability in all events is limited to the purchase value of the Unit only (excluding the costs of any taxes, shipping, assessments, tariffs, or any other ancillary costs).
- **UNDER NO CIRCUMSTANCES WILL GLOBAL COOLING, INC. BE RESPONSIBLE OR HELD LIABLE FOR CONSEQUENTIAL OR INCIDENTAL DAMAGES ASSOCIATED WITH LOSS OF STORED PRODUCT IN THE EVENT OF AN EQUIPMENT FAILURE.**
- **THE LIMITED WARRANTY CONTAINED HEREIN SHALL BE EXCLUSIVE AND IN LIEU OF ANY OTHER WARRANTIES, INCLUDING, WITHOUT LIMITATION, ANY WARRANTY OF FITNESS FOR A PARTICULAR PURPOSE OR WARRANTY OF MERCHANTABILITY OR ANY OTHER EXPRESS OR IMPLIED WARRANTIES WHICH MAY BE CLAIMED TO ARISE BY OPERATION OF LAW, CUSTOM, TRADE USAGE, OR COURSE OF DEALING.**

LIMITED WARRANTY, CANADA

- The warranty periods contained herein start **ONE MONTH** after the original date of shipment from Global Cooling, Inc.
- The Stirling Ultracold freezer is warranted for a full **SIX YEARS** for all labor and parts, including the Stirling engine and thermosiphon.
- If a service issue arises, contact Global Cooling, Inc. Service Department to register Warranty Service and initiate a resolution.
- Advanced authorization for a service company to diagnose the problem must be approved by Global Cooling, Inc.
- Global Cooling, Inc. will not be responsible for charges incurred for service calls made by a third party prior to authorization by Global Cooling, Inc.
- Global Cooling, Inc. retains the right to replace the Unit in lieu of servicing it in the field.
- Liability in all events is limited to the purchase value of the Unit only (excluding the costs of any taxes, shipping, assessments, tariffs, or any other ancillary costs).
- **UNDER NO CIRCUMSTANCES WILL GLOBAL COOLING, INC. BE RESPONSIBLE OR HELD LIABLE FOR CONSEQUENTIAL OR INCIDENTAL DAMAGES ASSOCIATED WITH LOSS OF STORED PRODUCT IN THE EVENT OF AN EQUIPMENT FAILURE.**
- **THE LIMITED WARRANTY CONTAINED HEREIN SHALL BE EXCLUSIVE AND IN LIEU OF ANY OTHER WARRANTIES, EXPRESS OR IMPLIED, WHICH MAY BE CLAIMED TO ARISE BY OPERATION OF LAW, CUSTOM, TRADE USAGE, OR COURSE OF DEALING.**

INTERNATIONAL DISTRIBUTOR LIMITED WARRANTY

- Warranty periods contained herein will start **ONE MONTH** after the ship date from Global Cooling.
- Global Cooling warrants that Distributor shall acquire products purchased hereunder free and clear of all liens and encumbrances.
- Global Cooling further warrants all Units to be free from defects in parts under normal use and service for a period of **SIX YEARS**, including the Stirling engine and thermosiphon.
- Global Cooling shall provide to Distributor, without charge, replacement parts to substitute for parts that must be replaced by reason of valid warranty claims.
- This warranty obligation is limited solely to the replacement of replaceable defective parts.
- All service charges with respect to the repair or replacement of defective parts of products shall be the responsibility of the Distributor and/or Distributor's customer.

- Distributor, on behalf of Global Cooling, shall perform such ordinary and customary servicing, repair and/or parts replacement within the Territory at Distributor's expense, which may be passed on to Distributor's customer, at Distributor's discretion.
- Liability in all events is limited to the purchase value of the Unit only (excluding the costs of any taxes, shipping, assessments, tariffs, or any other ancillary costs).
- **UNDER NO CIRCUMSTANCES WILL GLOBAL COOLING, INC. BE RESPONSIBLE OR HELD LIABLE FOR CONSEQUENTIAL OR INCIDENTAL DAMAGES ASSOCIATED WITH LOSS OF STORED PRODUCT IN THE EVENT OF AN EQUIPMENT FAILURE.**
- **THE LIMITED WARRANTY CONTAINED HEREIN SHALL BE EXCLUSIVE AND IN LIEU OF ANY OTHER WARRANTIES, EXPRESS OR IMPLIED, WHICH MAY BE CLAIMED TO ARISE BY OPERATION OF LAW, CUSTOM, TRADE USAGE, OR COURSE OF DEALING.**

THIS PAGE INTENTIONALLY LEFT BLANK



Stirling Ultracold

6000 Poston Road, Athens, Ohio 45701, USA

T 740.274.7900 / 1.855.274.7900 | F 740.274.7901

www.stirlingultracold.com

©2024 Stirling Ultracold, Global Cooling, Inc. All Rights Reserved.

Global Cooling technology is manufactured under U.S. and International patents.
Stirling Ultracold is a trademark of Global Cooling, Inc.
Specifications subject to change without notice.
Refer to stirlingultracold.com for the latest specifications.



STIRLING VAULT100™
OPERATING MANUAL
APPENDIX A



-20°C to -100°C
Upright Ultra-Low
Temperature Freezer

REDEFINING COLD



A.1 INFORMATION

Data Export

The flash drive provides the user with the ability to access a copy of the user log, the temperature charts, and the Stirling Ultracold service data file. The user log is in ascii/utf8 text, which can be viewed with many programs such as Notepad, WordPad, and Word, to name a few. The temperature charts can be viewed with any PDF reader, such as Adobe Acrobat, Foxit, and Sumatra. The charts are arranged such that Adobe Acrobat can flip through the charts one after the other. The only other file is the service data file with the name containing the serial number of the freezer and the extension '.su.'. The service file should be sent to Stirling Ultracold's service department for further evaluation if requested or required.

To retrieve data from the system:

- From the information screen, select the Data Export tab
- Insert a flash drive
- Select 'Export Data'

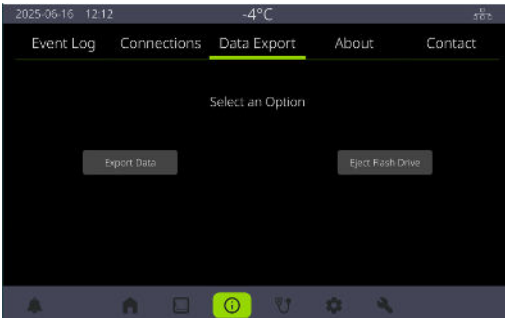

Wait while the system exports data.

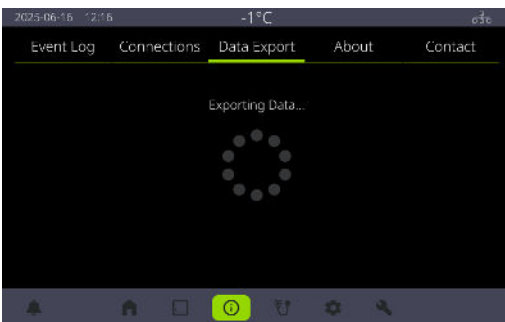

A.1 INFORMATION (CONTINUED)

'Success' is shown upon completion.

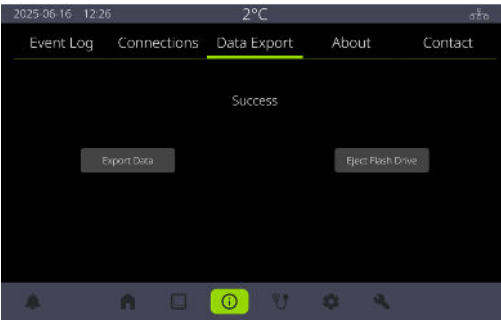

Now that the data has been transferred, it is OK to eject the flash drive. Press 'Eject Flash Drive'.

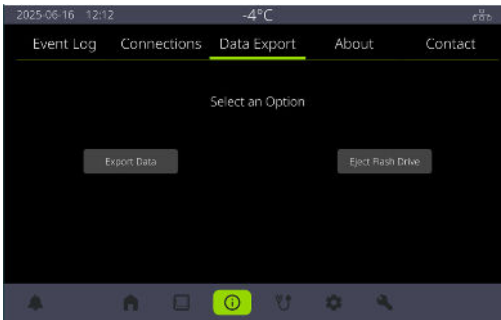

Wait while the system shuts down the files and ejects the flash drive.

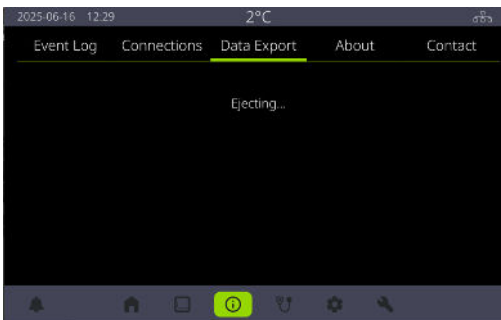

A.1 INFORMATION (CONTINUED)

Wait until complete before removing the flash drive from the system.

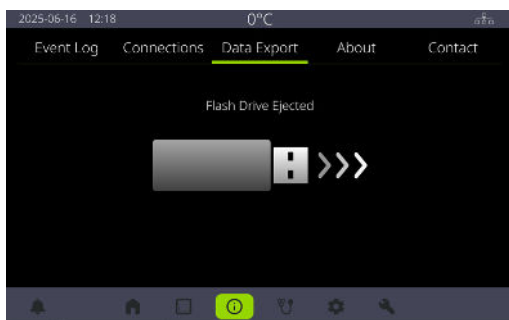

You may now remove the flash drive with your data.

Alarm Test

All operators/installers must test the dry contact outputs work as expected with the attached monitoring system.

Select 'Test' for the Alarm Test.

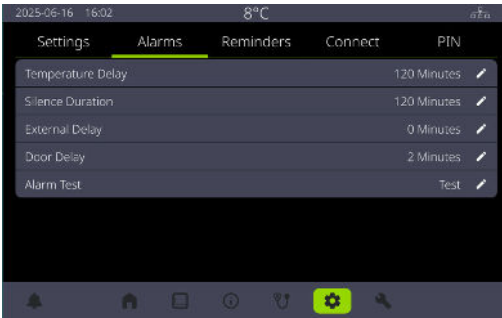

Once the Alarm Test window opens, press 'Start Test' to activate the fault signal on the external relays. Confirm the attached monitoring system sees a fault.

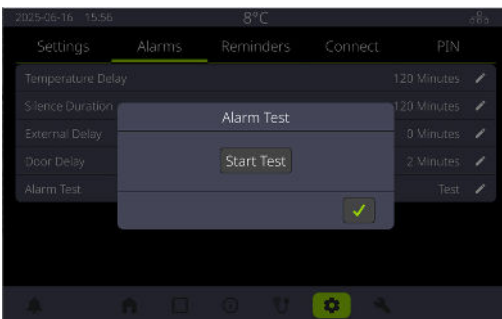

Press the 'Stop Test' button to disengage the fault signal. Confirm the attached monitoring system clears the fault note. (NOTE: An actual fault will override this signal, continuing to show fault on the dry contact output.)

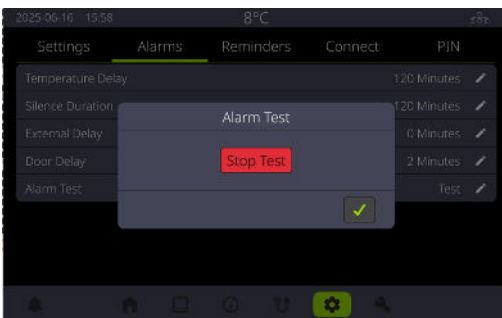

A.3 ALARMS & ALERTS/REMINDERS

Resetting Reminders - How to clear Alert Messages

NOTE: Operators may remove ice from the freezer and change the air filter. A qualified service technician must change the battery and service the engine fins.

Select 'Ice Removal Interval' to adjust how often the reminder will alert the operator.

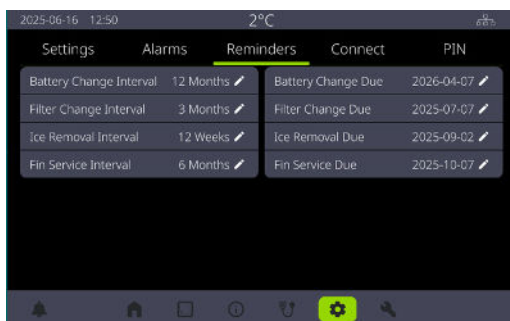

Adjust interval to an appropriate setting for your circumstances. Ice stops the freezer from optimum performance. Ice build-up decreases uniformity and increases power consumption.

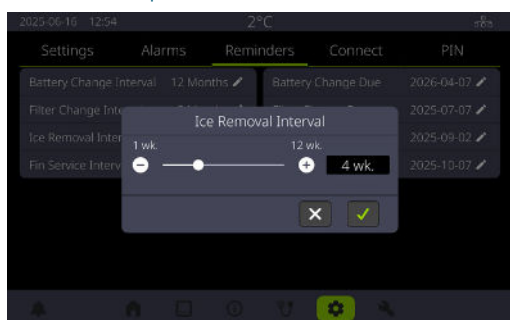

Select 'Ice Removal Due' to acknowledge the ice has been removed from the freezer in the gasket area and update the due date.

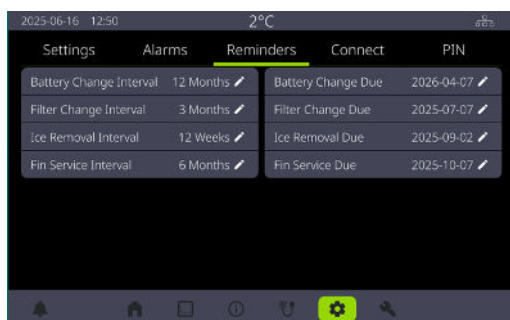

A.3 ALARMS & ALERTS/REMINDERS (CONTINUED)

Press the 'Hold to Update' button.

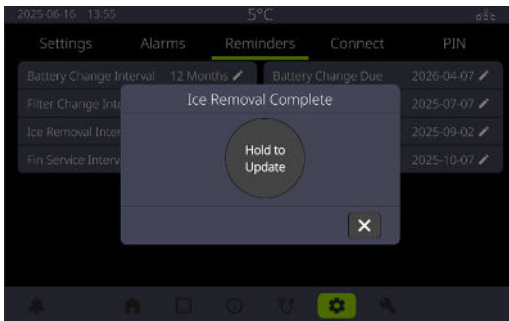

Keep hold of the 'Hold to Update' button until the update has completed.

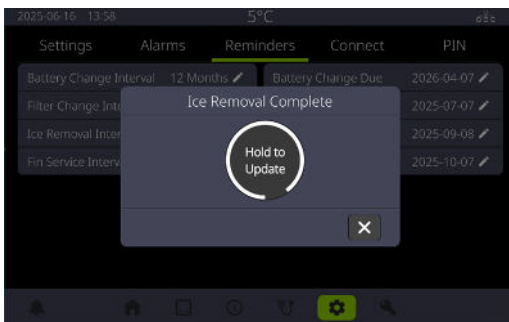

THIS PAGE INTENTIONALLY LEFT BLANK



Stirling Ultracold

6000 Poston Road, Athens, Ohio 45701, USA

T 740.274.7900 / 1.855.274.7900 | F 740.274.7901

www.stirlingultracold.com

©2024 Stirling Ultracold, Global Cooling, Inc. All Rights Reserved.

Global Cooling technology is manufactured under U.S. and International patents.
Stirling Ultracold is a trademark of Global Cooling, Inc.
Specifications subject to change without notice.
Refer to stirlingultracold.com for the latest specifications.

